



UC120-1V1S10 Universal Gateway

User Manual V1.0



Shenzhen Dinstar Co., Ltd.

Address: 9th Floor, Guoxing Building, Changxing Road, Nanshan District, Shenzhen, China

Postal Code: 518052

Telephone: +86 755 61919966

Fax: +86 755 2645 6659

Emails: sales@dinstar.com, support@dinstar.com

Website: www.dinstar.com

Preface

Welcome

Thanks for choosing the **UC120-1V1S10 Universal Gateway**! We hope you will make full use of this rich-feature gateway. Contact us if you need any technical support: 86-755-26456110/112.

About This Manual

This manual provides information about the introduction of the gateway, and about how to install, configure or use the gateway. Please read this document carefully before install the gateway.

Intended Audience

This manual is aimed primarily at the following people:

- Users
- Engineers who install, configure and maintain the gateway.

Revision Record

Document Name	Document Version	Firmware Version
UC120-1V1S10 Universal Gateway User Manual V1.0	V1.0 (2019/11/25)	2.55.1.4

Conventions

Gateway or device mentioned in this document refers to the UC120-1V1S10 gateway. Those words in blue are the contents that users need to pay attention to.

Contents

1 Product Introduction	1
1.1 Overview	1
1.2 Application Scenario	1
1.3 Product Appearance	2
1.4 Description of Indicators	3
1.5 Features & Functions.....	4
1.5.1 Key Features	4
1.5.2 Physical Interfaces	4
1.5.3 Voice Capabilities	5
1.5.4 FXS.....	5
1.5.5 FXO	5
1.5.6 Software Features	6
1.5.7 Supplementary Services.....	6
1.5.8 Environmental	6
1.5.9 Maintenance	7
2 Quick Installation.....	8
2.1 Installation Attentions.....	8
2.2 Installation Steps	8
2.3 Network Connection.....	9
2.3.1 Network Connection Diagram under Route Mode.....	9
2.3.2 Network Connection Diagram under Bridge Mode	9
2.4 Connect Gateway to Network	10
2.4.1 Connect Gateway to Network via Network Port.....	10
2.4.2 Connect Gateway to Network via WiFi.....	10
2.4.3 Preparations for Login	11
2.4.4 Log In Web Interfacer	11
3 Basic Operation	12
3.1 Methods to Number Dialing	12
3.2 Call Holding.....	12
3.3 Call Waiting	12
3.4 Call Transfer.....	12

3.4.1 Blind Transfer.....	12
3.4.2 Attended Transfer	13
3.5 Three-way Conference.....	14
3.6 Switching Bwtween Two Calls	14
3.7 Description of Feature Code	15
3.8 Send or Receive Fax	16
3.8.1 Fax Mode Supported	16
3.8.2 Explanation of T.38 and Pass-through.....	16
3.9 Function of RST Button.....	17
3.10 Query IP Address and Restore Default Setting	18
4 Configuration Wizard.....	19
4.1 Configuration Wizard	19
4.1.1 UC120 Regarded as Terminal and Registered to SIP Server	19
4.1.2 Other SIP Clients registered to UC120.....	20
4.1.3 UC120 Connected to PBX through Trunking	20
4.1.4 UC120 Serving as VPN Client.....	20
5 Configurations on Web Interface	21
5.1 Introduction to Web Interface	21
5.2 Status.....	22
5.2.1 Overview.....	22
5.2.2 SIP	23
5.2.3 PSTN.....	23
5.2.4 DHCP Client List.....	25
5.2.5 Fail2ban.....	25
5.2.6 VPN	25
5.2.7 Current Call.....	26
5.2.8 Parking Lot.....	26
5.2.9 CDRs.....	26
5.2.10 Service.....	27
5.2.11 Performance.....	27
5.2.12 About.....	28
5.3 System.....	29
5.3.1 Setting	29
5.3.2 User Manager	30
5.3.3 Provision	32
5.3.4 Operation Log	33
5.3.5 Service Log	34

5.3.6 Config Changes Log	34
5.3.7 Backup/Restore/Upgrade	34
5.3.8 Voice	36
5.3.9 Command Line	36
5.3.10 Diagnostics	36
5.3.11 Cloud Service	37
5.3.12 API	38
5.3.13 Event Report	38
5.3.14 Schedul Task	39
5.3.15 Email	40
5.3.16 FTP Server	41
5.3.17 Disk Manager	41
5.3.18 Reboot	42
5.4 Network	42
5.4.1 Setting	42
5.4.2 VoLTE	45
5.4.3 Uplink Config	46
5.4.4 Access Control	48
5.4.5 Firewall	49
5.4.6 DHCP Server	50
5.4.7 Port Mapping	51
5.4.8 DMZ Setting	53
5.4.9 Diagnostics	53
5.4.10 VPN	54
5.4.11 Static Route	59
5.4.12 Hosts	60
5.4.13 Fail2ban	60
5.5 Profile	62
5.5.1 SIP	62
5.5.2 FXS/FXO	65
5.5.3 Codec	72
5.5.4 Number	72
5.5.5 SIM Number Learning	75
5.5.6 Time	76
5.5.7 Manipulation	76
5.5.8 Speed Dial	77
5.5.9 Dialplan	78
5.5.10 AutoCLIP	80

5.5.11 Recording	81
5.5.12 Voice Mail	83
5.6 Extension	85
5.6.1 SIP	85
5.6.2 FXS	87
5.6.3 Ring Group	89
5.6.4 Paging Group	90
5.7 Trunk	91
5.7.1 SIP	91
5.7.2 FXO	93
5.7.3 VoLTE Trunk	96
5.8 Call Control	99
5.8.1 Setting	100
5.8.2 Route Group	101
5.8.3 Route	102
5.8.4 Feature Code	104
5.8.5 IVR	105
5.8.6 SMS Route	106
5.8.7 SMS	107
5.8.8 USSD	109
5.8.9 Diagnostics	109
6 Glossary	111

1 Product Introduction

1.1 Overview

The UC120-1V1S1O gateway is a multi-functional and all-in-one gateway, which integrates voice service (VoLTE, VoIP and PSTN) and data service (LTE 4G/WCDMA 3G). It provides three interfaces (including LTE, FXS and FXO), offering seamless connectivity to VoIP Network, PLMN and PSTN.

Based on SIP, UC120-1V1S1O not only can interact with IPPBX, softswitch and SIP-based network platforms, but also supports types of WCDMA/LTE frequency ranges, thus meeting the worldwide requirements about the mobile network.

Besides, the gateway has built-in WiFi and high-speed data handling capacity, allowing users to enjoy high-speed internet surfing through WiFi or LAN ports.

UC120-1V1S1O is ideally suitable for personal use. Meanwhile, it is perfect for small and micro enterprises, offering high-speed internet access, good voice service and message service.

1.2 Application Scenario

The application scenario of UC120-1V1S1O universal gateway is shown as follows:

Figure 1-1 Application Scenario of UC120-1V1S1O

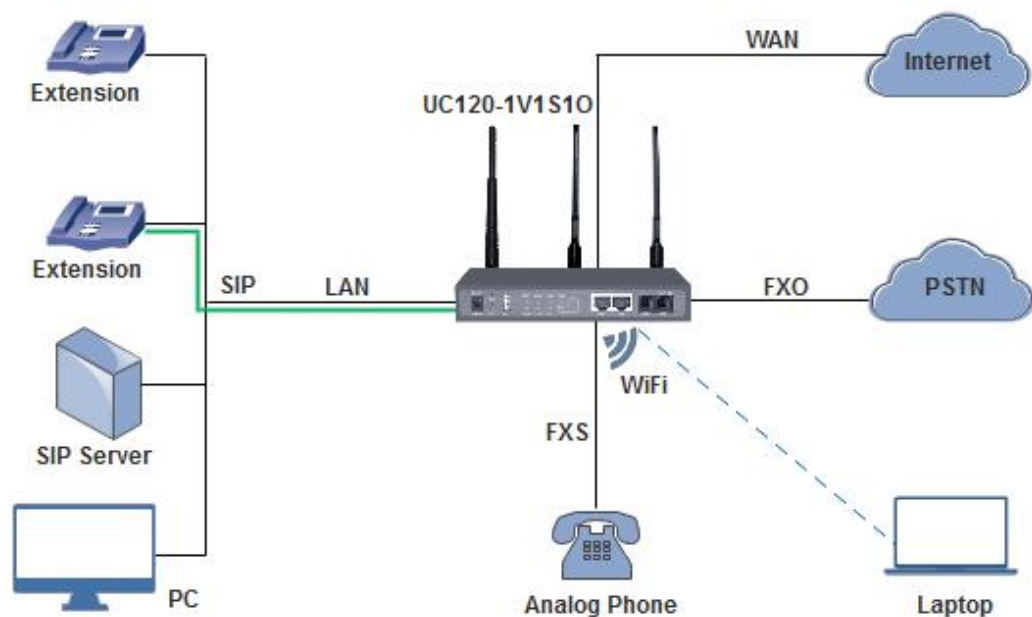

1.3 Product Appearance

Front View:



Back View:



1.4 Description of Indicators

Indicator	Definition	Status	Description
PWR	Power Indicator	Off	There is no power supply or power supply is abnormal.
		On	The UC120 device is powered on.
RUN	Running Indicator	Slow Flashing	The device is initialized successfully and is running normally
		On	The device is being initialized.
		Off	The device is not running normally.
WiFi	WiFi Indicator	Fast Flashing	WiFi is in normal running.
		Off	WiFi is disabled or WiFi is faulty
		On	The WiFi module malfunctions.
FXS	FXS In-use Indicator	Slow Flashing	The FXS port is initialized successfully and is in idle status
		On	The FXS port is in off-hook (in-use) status.
		Off	The FXS port is faulty
FXO	FXO In-use Indicator	Fast Flashing	The FXO port is connected with PSTN line and is in idle status
		Slow Flashing	The FXO port has yet to be connected with PSTN line, but is in normal status.
		On	The FXO port is currently occupied by a call.
		Off	The FXO port is faulty.
WAN/LAN	Network Connection Indicator	Off	Network does not work or network cable is not connected to the WAN/LAN port..
		Fast Flashing	Network is successfully connected.
SIM	LTE 4G Indicator	<p>(1) LTE indicator (2) Strong signaling indicator (3) Weak signaling indicator</p> <p>When these three indicators are all dull (off), it means that the VoLTE module does not exist.</p> <p>When the LTE indicator fast flashes and at the meantime, both the strong signaling indicator and the weak signaling indicator are dull, it means the VoLTE module malfunctions.</p> <p>When the LTE indicator is on, and at the meantime, both the strong signaling indicator and the weak signaling indicator are dull, it means that the VoLTE module works normally but no SIM is</p>	

		<p>inserted.</p> <p>When the LTE indicator is on, and at the meantime, the strong signaling indicator is dull and the weak signaling indicator fast flashes, it means that the VoLTE module works normally but the SIM card is faulty.</p> <p>When the LTE indicator is on, and at the meantime, the strong signaling indicator is dull and the weak signaling indicator slow flashes, it means that both the VoLTE module and the SIM card work normally and the SIM card is being registered/dialed.</p> <p>When the LTE indicator is on, and at the meantime, the strong signaling indicator is dull and the weak signaling indicator is on, it means that both the VoLTE module and the SIM card work normally and the SIM card can be registered/dialed properly.</p> <p>When these three indicators are all on, it means that both the VoLTE module and the SIM card work normally and the SIM card can be registered/dialed properly.</p>
--	--	--

1.5 Features & Functions

1.5.1 Key Features

- FXS/FXO/LTE interface on a single gateway
- Send/receive calls from LTE and from PSTN/PLMN via FXO
- Flexible dial plan and routing strategies based on time, number and source IP etc.
- IVR Customization
- Support high-speed NAT forwarding and WiFi hotspot
- Serve as VPN client
- Support voice mail and call recording
- Built-in SIP server, support up to 60SIP extensions and 15 concurrent calls
- User-friendly web interface, multiple management ways

1.5.2 Physical Interfaces

- FXS Port: 1
- FXO Port: 1
- USB port: 1

- SIM Slot: 1
- SD Slot: 1
- Network Port: 1 WAN Port & 1 LAN Ports (10/100 Base-T RJ45)
- WiFi: 2.4Ghz 802.11n

1.5.3 Voice Capabilities

- VoIP Protocols: SIP over UDP/TCP/TLS, SDP, RTP/SRTP
- Codecs: G.711a/μ law, G.723.1, G.729A/B, G722
- Silence Suppression
- Comfort Noise Generator(CNG)
- Voice Activity Detection(VAD)
- Echo Cancellation: G.168 with up to 128ms
- Dynamic Jitter Buffer
- Adjustable Gain Control
- Automatic Gain Control (AGC)
- Call Progress Tones: Dial Tone, Ring Back Tone, Busy Tone
- FAX: T.38 and Pass-through
- NAT Traversal: STUN/UPnP
- DTMF: RFC2833/Signal/Inband

1.5.4 FXS

- FXS Connector: RJ11
- Caller ID: Bellcore Type 1&2, ETSI, BT, NTT and DTMF
- Answer and Disconnect Signaling: Answer, Disconnect, Busy Tone
- Polarity Reversal
- Hook Flash

1.5.5 FXO

- FXO Connector: RJ11
- Caller ID: FSK and DTMF
- Polarity Reversal
- Answer Delay
- Busy Tone Detection
- No Current Detection

1.5.6 Software Features

- Ring Group
- Routing Groups
- Caller/Called Number Manipulation
- Routing Based on Time Period
- Routing Based on Caller/Called Number Prefix
- Routing Based on Source Trunks
- Dial Rules
- Failover Routing
- FXO Impedance Auto Match
- IVR Customization
- Auto Attendant Function
- CDRs

1.5.7 Supplementary Services

- Call Forwarding (Unconditional/Busy/No Reply)
- Call Waiting and Call Holding
- Call Transfer (Blind & Attended)
- Call Queuing
- Intra-group Pick-up
- Auto-answer
- Hotline
- No Disturbing
- Voice Mail
- Three-way Conversation

1.5.8 Environmental

- Power Supply: 12VDC, 2A
- Power Consumption: 18W
- Operating Temperature: 0 °C ~ 45 °C
Storage Temperature: -20 °C~80 °C
- Humidity: 10%-90% (Non-Condensing)
- Dimensions: 260×180×35mm (W/D/H)
- Weight: 1.0kg

1.5.9 Maintenance

- Web GUI for Configuration
- Telnet Management
- Configuration Restore & Backup
- Multiple Languages
- Firmware Upgrade: support HTTP/HTTPS/TFTP/FTP
- Auto Provision
- CDR Query and Export
- Syslog Query and Export
- Network Tools: Ping, Traceroute and Nslookup
- Flow Statistics: TCP, UDP, RTP
- Network Capture

2 Quick Installation

2.1 Installation Attentions

To avoid unexpected accident or device damage, please read the following instructions before you install the UC120-1V1S1O gateway.

- The adapter of the gateway accepts DC input voltage of 12V 2A. Please ensure stable and safe power supply;
- To reduce the interference to telephone calls, please separate power cables from telephone lines;
- To guarantee stable running of the gateway, please make sure that there is enough network bandwidth;
- For better heat dissipation, please place the gateway on a flat surface and do not pile up with other devices;
- If WiFi is enabled, please ensure the WiFi antennas are well connected with the gateway
- If you want the gateway to communicate with the LTE network, please insert a SIM card.

2.2 Installation Steps

- Connect WiFi antenna to the WiFi antenna interface of the gateway, and then connect the LTE antennas to WiFi antenna interfaces.

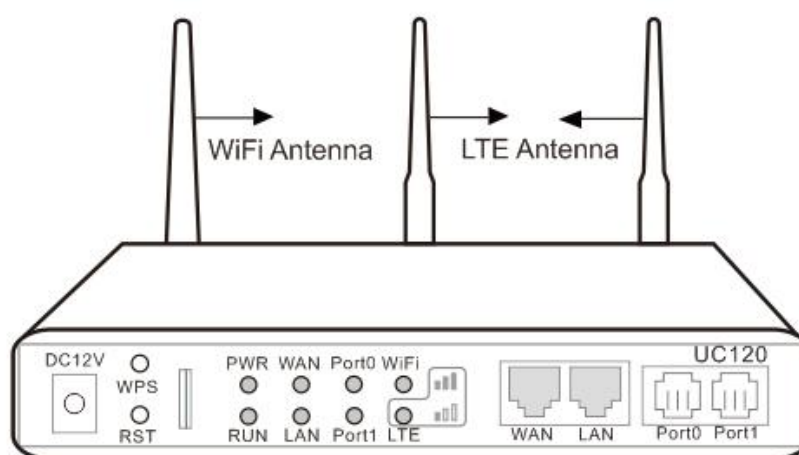

- Connect the power adapter to the power jack;
- Connect telephone line to the FXS port and connect PSTN line to the FXO port;

- Connect network cable to the LAN port(s) and WAN port (please refer to 2.3 Network Connection);
- Insert a SIM card to the SIM slot, with the chip facing down.

2.3 Network Connection

UC120-1V1S10 works in two network modes: route mode and bridge mode. When it is under the route mode, the IP address of WAN port must be different from the IP address of LAN port. But when it is under the bridge mode, the IP address of WAN port and that of LAN port are the same.

2.3.1 Network Connection Diagram under Route Mode

Under the route mode, the default IP address of WAN port is a DHCP IP address, while the default IP address of the LAN port is a static IP address, namely 192.168.11.1.

Figure 2-1 Network Connection Diagram under Route Mode

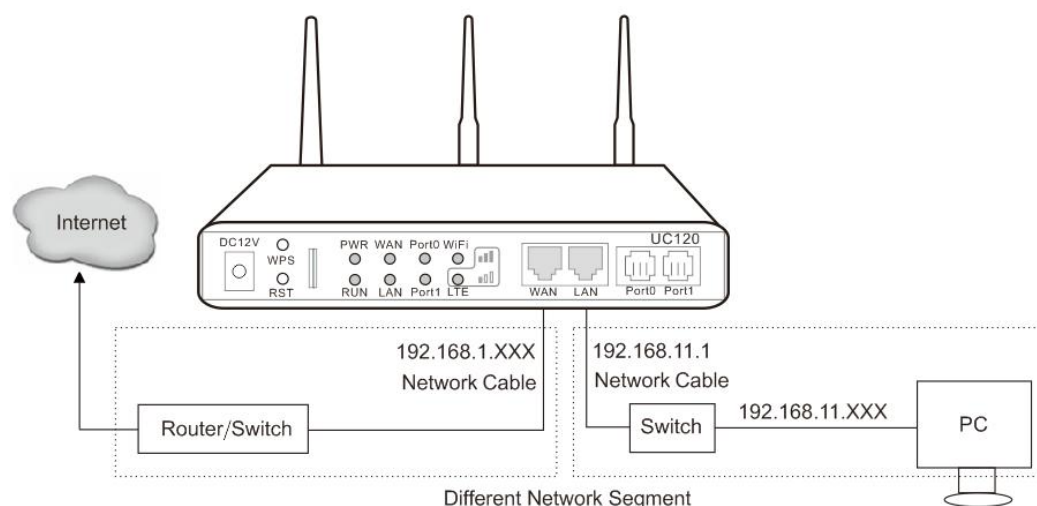

Note: The IP address of LAN port of the gateway and the IP address of PC must be at the same network segment, while that of WAN port is at a different network segment.

2.3.2 Network Connection Diagram under Bridge Mode

Under the Bridge mode, the IP address of WAN port is the same with that of LAN port. Generally, when the gateway works under the bridge mode, the IP address of the gateway has been modified. In the following diagram, it is assumed that the IP address has been modified into 172.16.80.1.

Figure 2-2 Network Connection Diagram under Bridge Mode

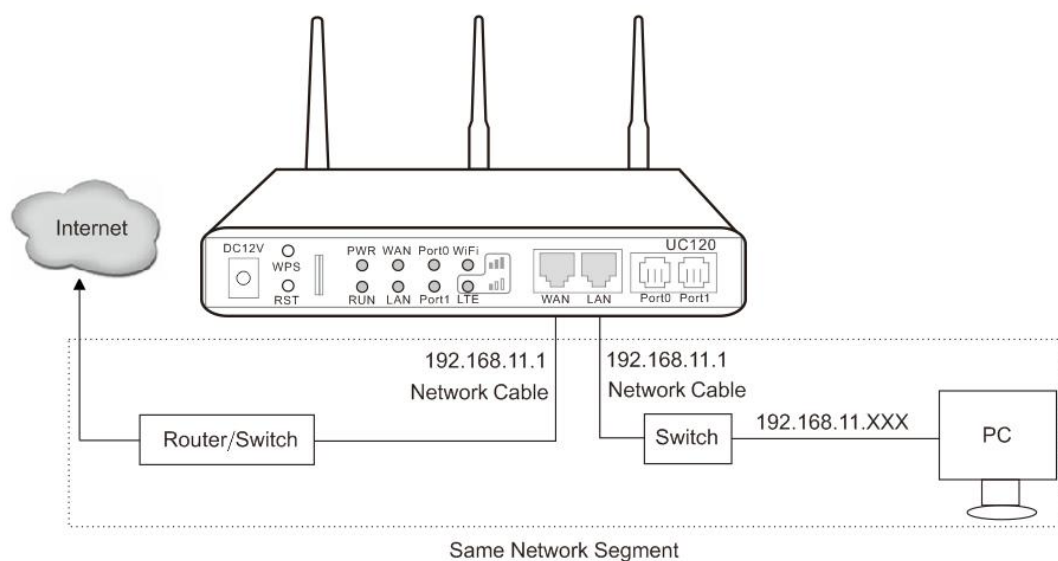

Note: The IP address of PC and that of WAN port of the UC120-1V1S1O gateway are at the same network segment.

2.4 Connect Gateway to Network

The above network diagrams show how to connect the gateway to network through network ports. In fact, the gateway can also be connected to network through WiFi.

2.4.1 Connect Gateway to Network via Network Port

Please connect the UC120-1V1S1O gateway to network according to the network diagrams in Section 2.3 Network Connection. Then connect a telephone to the FXS port. Dial *158# to query the IP address of LAN port. Modify the IP address of PC to make it at the same network segment of LAN port of the gateway.

You are also allowed to log in the gateway by using the WAN PORT, but you need to

2.4.2 Connect Gateway to Network via WiFi

Connect power source to the gateway, and then use a laptop to search the SSID of the gateway. The default SSID is domain_the last six characters of the Mac address, for example, if the mac address is F8-A0-3D-59-09-A3, the default SSID is domain_5909a3.

By default, there is no password for WiFi, and the built-in DHCP server is turned on.

2.4.3 Preparations for Login

Modify the IP address of the PC to make it at the same network segment with the UC120-1V1S1O gateway, since the default IP address of LAN port of the gateway is 192.168.11.1.

Check the connectivity between the PC and the UC120-1V1S1O. Click **Start** → **Run** of PC and enter cmd to execute 'ping 192.168.11.1' to check whether the IP address of LAN port runs normally.

2.4.4 Log In Web Interfacer

Open a web browser and enter the IP address of LAN port (the default IP is 192.168.11.1). Then the login GUI will be displayed.

You also can enter the IP address of WAN port, but it's required to modify the IP address of PC to make it at the same network segment with that of WAN port.

It is suggested that you should modify the username and password for security consideration.

Figure 2-3 Login GUI of UC120-1V1S1O

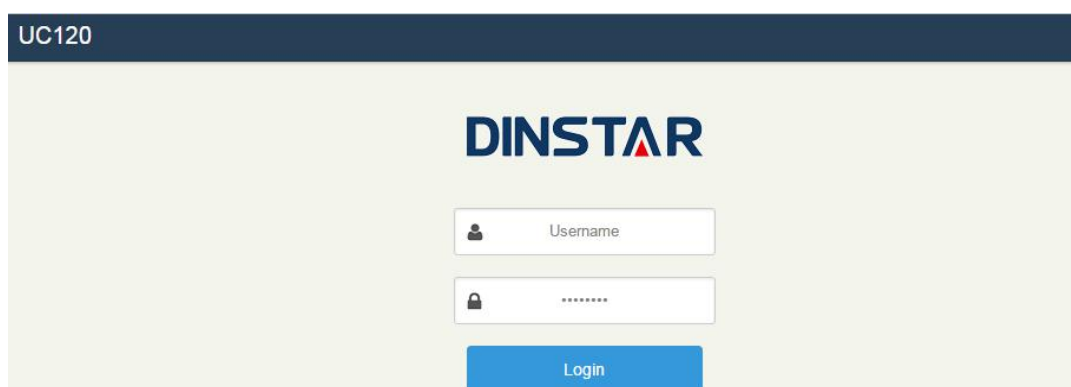

By default, the username is admin, while the password is admin@123#. After entering username and password, click **Login** to enter into the web interface.

Under some circumstances, login of the Web will be limited:

- For three consecutive login failures, you need to slide to validate your user account;
- Failing to log in the Web for ten times consecutively, the IP address of the UC120 device will be put into the blacklist, and you need to reset a new IP address for the device;
- Successful login or device restart will wipe out login failure records.

3 Basic Operation

3.1 Methods to Number Dialing

There are two methods to dial telephone number or extension number:

- Dial the called number and wait for 4 seconds for dialing timeout, or dial the called number directly (the system will judge whether the dialing is completed according to Digitmap and Regular Expression dialplans).
- Dial the called number and press #.

3.2 Call Holding

If a calling party places a call to a called party which is otherwise engaged, and the called party has the call holding feature enabled, the called party is able to switch to the new incoming call while keeping the current call holding on by pressing the flash button or the flash hook.

When the called party presses the flash button or the flash hook once again, he or she will switch back to the first call.

3.3 Call Waiting

If a calling party places a call to a called party which is otherwise engaged, and the called party has the call waiting feature enabled, the calling party will hear a IVR voice 'Please hold on, the subscriber you dialed is busy' and the called party will hear three beeps.

By pressing the flash button or the flash hook, the called party is able to switch between the new incoming call and the current call.

3.4 Call Transfer

3.4.1 Blind Transfer

Blind transfer is a call transfer in which the transferring party connects the call to a third party without notifying the third party.

Example: A gives a call to B and B wants to blindly transfer the call to C. Operation instructions are as follows:

1. A dials the extension number of B;
2. The extension of B rings, and B picks up the phone. Then A and B go into conversation;
3. B presses *1 to trigger blind transfer (at the same time, A can hear the waiting tone). Then B dials the extension number of C (end up with # or wait for 4 seconds);
4. The extension of C rings, B hangs up the phone and C picks up the phone. Then C and A goes into conversation.

Note:

- On the 'Call Control → Feature Code' page, feature code service should be 'On'.
- If B hears continuous busy tones after he dials the extension number of C, it means the call has timed out.

3.4.2 Attended Transfer

Attended transfer is a call transfer in which the transferring party connects the call to a third party after he confirms that the third party agrees to answer the call.

Example: A gives a call to B and B wants to attended transfer the call to C. Operation instructions are as follows:

1. A dials the extension number of B;
2. The extension of B rings, and B picks up the phone. Then A and B go into conversation;
3. B presses *2 to trigger attended transfer (at the same time, A can hear a waiting tone). Then B dials the extension number of C;
4. Then one of the following situations will happen:
 - a. If the extension of C cannot be reached because the dialing/call has timed out, C rejects the call or C is busy, B will automatically switch to the conversation with A.
 - b. The extension of C rings (at the same time, B can hear a ringback tone). If B hangs up the phone at this moment, A will continue to hear the waiting tone. Then if A also hangs up the phone, the extension of C will continue to ring. If C picks up the phone at this moment, the call will end directly.
 - c. The extension of C rings and then C picks up the phone. C and B go into conversation, and A will continue to hear a waiting tone. If it's B that hangs up the phone at this moment, C and A go into conversation. If it's C that hangs up the phone, B and A go into conversation.

3.5 Three-way Conference

When the FXS port of UC120 is the caller:

Step1. A dials the number of B and B picks up the phone, and then A and B go into conversation;

Step2. A presses the flash hook, and then dial the number of C after hearing the dialing tone.

Step3. C pick up the phone, and A and C go into conversation and meanwhile the call between A and B is kept holding.

Step4. Then, if A presses the flash hook and dials 1, the conversation will switch back to A and B; if A presses the flash hook and dial 2 , the conversation will switch to A and C; if A presses the flash hook and dial 3, the conversation will switch to A , B and C (three-party conversation).

When the FXS port of UC120 is the callee:

Step1. B places a call to A, and A picks up the phone after the phone rings. And then C also gives a call to A (at the same time, A can hear a waiting tone).

Step2. If A presses the flash hook, A and C go into conversation and meanwhile the call between A and B is kept holding.

After that, if A dials 1, the conversation will switch back to A and B; if A dial 2 , the conversation will switch to A and C; if A dials 3, the conversation will switch to A , B and C (three-party conversation).

Step2 (optional). When C is calling A and B hands up the phone during the process, A and C will automatically go into conversation.

3.6 Switching Bwtween Two Calls

When the FXS port of UC120 is the caller:

Step1. A dials the number of B and B picks up the phone, and then A and B go into conversation;

Step2. A presses the flash hook, and then dial the number of C after hearing the dialing tone.

Step3. C pick up the phone, and A and C go into conversation and meanwhile the call between A and B is kept holding.

Step4. If A presses the flash hook again, and the call will be switched back to A and B. If A presses the flash hook once more, the call will be switched to A and C.

When the FXS port of UC120 is the callee:

Step1. B places a call to A, and A picks up the phone after the phone rings. And then C also gives a call to A (at the same time, A can hear a waiting tone).

Step2. If A presses the flash hook, A and C go into conversation and meanwhile the call between A and B is kept holding.

After that, if A presses the flash hook again, and the call will be switched back to A and B. If A presses the flash hook once more, the call will be switched to A and C.

3.7 Description of Feature Code

UC120-1V1S10 provides convenient telephone functions. Connect a telephone to the FXS port and dial a specific feature code, and you can query corresponding information.

Code	Corresponding Function
*159	Dial *159 to inquiry WAN IP
*158	Dial *158 to inquiry LAN IP
*114	Dial *114 to inquiry phone number
157	Dial *157*0 to set route mode; dial *157*1 to set bride mode
150	Dial *150*1 to set IP address as static IP address; dial *150*2 to set IP address as DHCP IP address
152	Dial *152* to set IPv4 address, for example: Dial *152*192*168*1*10# to set IPv4 address as 192.168.1.10
156	Dial *156* to set IPv4 gateway, for example: Dial *156*192*168*1*1# to set IPv4 gateway as 192.168.1.1
153	Dial *153* to set IPv4 netmask, for example: Dial *153*255*255*0*0*# to set IPv4 netmask as 255.255.0.0
*111	Dial *111 to restart the UC120 device
*51	Dial *51 to enable the call waiting service
*50	Dial *50 to disable the call waiting service
*1	Dial *1 to trigger blind transfer, for example: Dial *18000, and you can blind transfer to the extension number 8000
*2	Dial *2 to trigger attended transfer, for example: Dial *28000#, and you can attended transfer to the extension number 8000
72	Enable unconditional call forwarding service. Example: Dial *72*8000,

	and calls will be unconditionally forwarded to extension number 8000
*73	Disable unconditional call forwarding service
90	Enable the 'call forwarding on busy' service. Example: Dial *90*8000, and calls will be forwarded to extension number 8000 when the called number is busy
*91	Disable the 'call forwarding on busy' service
92	Enable the 'call forwarding on no reply' service. Example: Dial *92*8000, and calls will be forwarded to extension number 8000 when there is no reply from the called number
*93	Disable the 'call forwarding on no reply' service
*78	Enable the 'No Disturbing' service
*79	Disable the 'No Disturbing' service
**	Pick up the ringing extension which is in the same ringgroup. Example: Dial**8000, and you can take the incoming call of extension number 8000
160	Dial *160*1# to allow HTTP WAN access, Dial *160*0# to deny HTTP WAN access

Note:

A voice prompt indicating successful configuration will be given after each configuration procedure. Please do not hang up until hearing this voice prompt.

3.8 Send or Receive Fax

3.8.1 Fax Mode Supported

- T.38 (IP-based)
- T.30 (Pass-Through)

3.8.2 Explanation of T.38 and Pass-through

T.38 is an ITU recommendation for allowing transmission of fax over IP networks in real time. Under the T.38 mode, analog fax signal is converted into digital signal and fax signal tone is restored according to the signal of peer device. Under the T.38 mode, fax traffic is carried in T.38 packages.

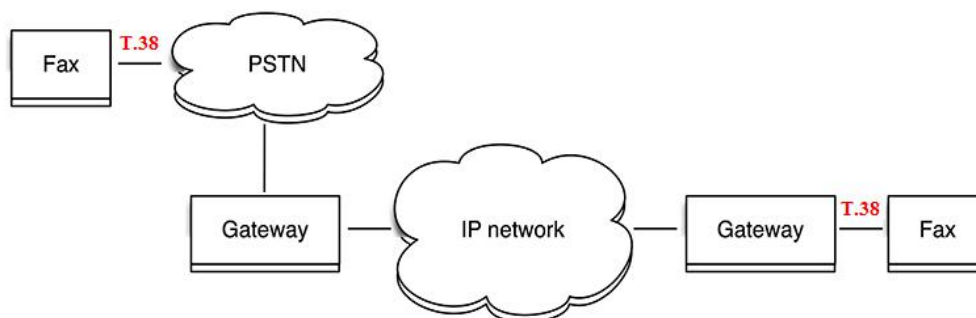

Pass-through: Under the pass-through mode, fax signal is not converted and fax traffic is carried in RTP packets. It uses the G.711 A or G.711U codec in order to reduce the damage to fax signal.

3.9 Function of RST Button

Press the RST button for different time length, and the UC120-1V1S10 device will execute different function:

1. On the condition that the device is running normally, press the RST button for 3 to 6 seconds, the login password of the device will be restored to the factory default, and the network mode will become the route mode, with WAN address obtained through DHCP and LAN IP address defaulted as 192.16.11.1. At the meanwhile, the access ports of Http, Https, Telnet and SSH are restored to the default settings.

Figure 3-1 Default settings of Http, Https, Telnet and SSH

Network / Access Control	
Web Server	
HTTP Port	80
Allow WAN access	<input type="checkbox"/>
HTTPS Port	443
Allow WAN access	<input type="checkbox"/>
Telnet	
Enable	<input checked="" type="checkbox"/>
Port	23
Allow WAN access	<input type="checkbox"/>
SSH	
Port	22
Allow WAN access	<input type="checkbox"/>
<input type="button" value="Cancel"/> <input type="button" value="Save"/> <input type="button" value="Reset"/>	

2. On the condition that the device is running normally, press the RST button for 6 to 12 seconds, and all configurations are restored to the default settings.
3. On the condition that the device is powered off, press the RST button and the WPS button, and connect the UC120 gateway with power source. After about 30 seconds, the device will wipe out all configurations, rebuild a file system and then re-load a firmware version (this method is used in case of version fault).

3.10 Query IP Address and Restore Default Setting

After connecting a telephone to the FXS port, you can dial *158 to query the IP address of LAN port and dial *159 to query the IP address of WAN port.

If you want to restore UC120-1V1S10 to default settings, you can press the **RST** button for 6 to 12 seconds or you can configure it on the Web interface.

On the Web interface, click **System** → **Backup/Restore/Upgrade** and then select the parts (system, network or service) that need to be restored to default settings. Click **Reset** and then restart the device, and the selected parts will be restored to default settings.

Figure 3-2 Reset to Defaults

The screenshot shows the 'System / Backup/Restore' web interface. It contains three main sections:

- Choose backup files and download:** Includes checkboxes for 'System', 'Network', and 'Service', all of which are checked. A blue 'Download' button is on the right.
- Reset to defaults:** Includes checkboxes for 'System', 'Network', and 'Service'. 'System' and 'Service' are checked, while 'Network' is unchecked. A blue 'Reset' button is on the right.
- Restore backup:** Includes a 'Choose File' button and a text field containing 'No file chosen'. A grey 'Restore' button is on the right.

4 Configuration Wizard

4.1 Configuration Wizard

The following are the common ways to configure the UC120-1V1S10 gateway.

4.1.1 UC120 Regarded as Terminal and Registered to SIP Server

1. UC120-1V1S10 Registered to SIP Server

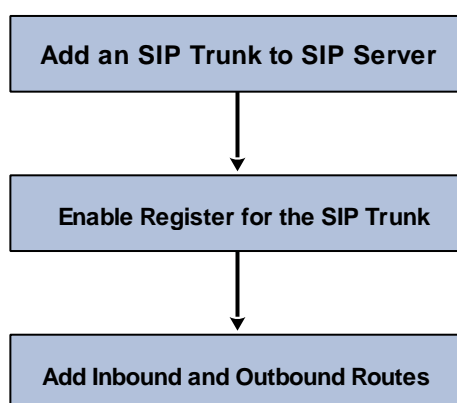

2. FXS/FXO Port Registered to SIP Server

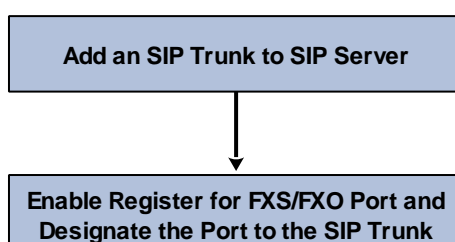

Note: Although 'Register' has been enabled for FXS/FXO port, calls through FXS/FXO port will take inbound and outbound routes as first priority. For outgoing calls, if outbound route cannot be matched, then the registered SIP trunk will be selected. For incoming calls, if inbound route cannot be matched, then the registered FXS/FXO port will be selected.

Generally, local extension number is taken as first priority for call routing selection, followed by DID, route and then registered port.

4.1.2 Other SIP Clients registered to UC120

Under this mode, UC120-1V1S10 is regarded as an SIP Server. Create an extension account first on the **Extension → SIP** interface, and configure listening port on the **Profile → SIP** interface. Then, configure the IP address, extension account and listening port of UC120-1V1S10 on SIP client.

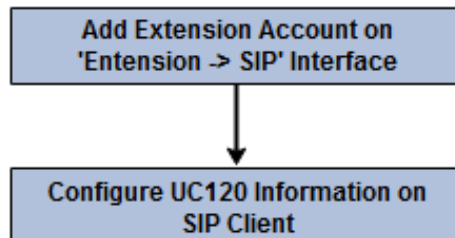

4.1.3 UC120 Connected to PBX through Trunking

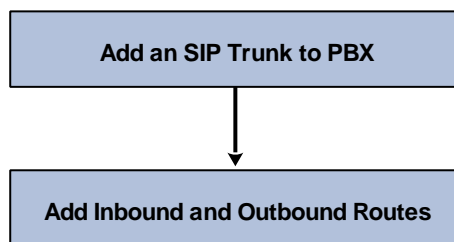

4.1.4 UC120 Serving as VPN Client

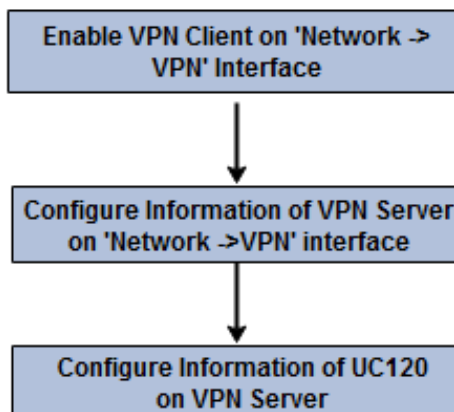

5 Configurations on Web Interface

5.1 Introduction to Web Interface

Modify the IP address of PC to make it at the same network segment with that of LAN port of the UC120-1V1S10 gateway (the default IP of LAN port is 192.168.11.1).

Open a web browser on the PC and then enter the IP address of LAN port. Click **Login**, and the login GUI is displayed. Both the default username and password are admin.

The displayed login GUI is shown as follows:

Figure 5-1 Introduction to login GUI

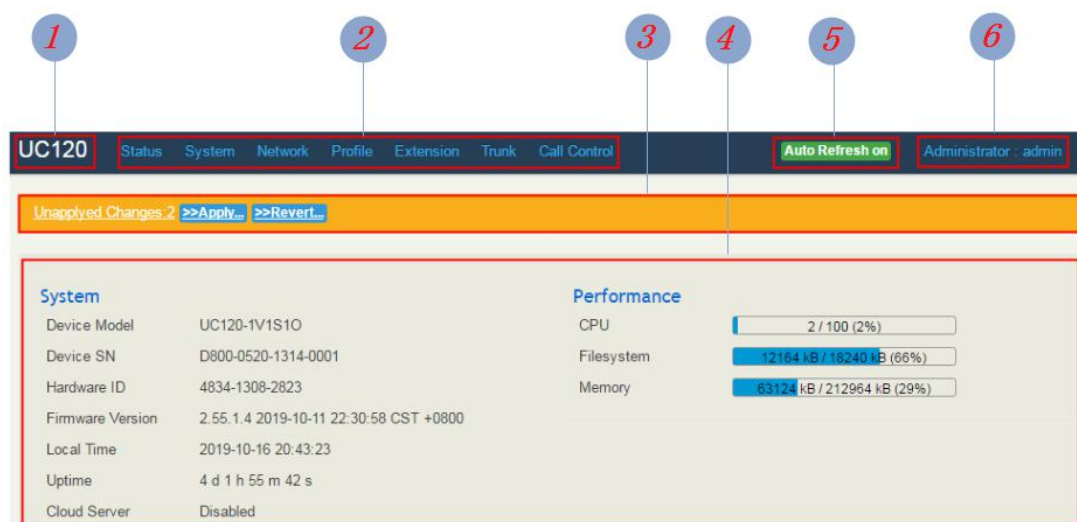

Table 5-1 Introduction of Web Interface

Index	Item	Description
1	UC120	The name of the gateway; it can be edited on the System → Setting interface
2	Menu Bar	The menu bar of UC120-1V1S10
3	Unsaved Changes	All changes to the configuration of the gateway need to be saved. Click Apply to enter into the page to save the changes; click Revert to return to original configuration.
4	Detailed Interface	The detailed configuration interface or display interface
5	Auto Refresh Button	The button can be enabled or disabled. If it is enabled, the information on the Status → Overview/SIP/PSTN/Current

		Call interfaces will be refreshed automatically
6	User Role	The role of the current user logging into the Web. And the “exit” sign will pop up when the mouse moves over there. You can log out of the web from there



5.2 Status

The ‘Status’ meun mainly displays all kinds of status information. It includes the following sub-menus: Overview, SIP, PSTN, DHCP Client List, VPN, Parking Lot, Current Call, CDRs, Service, performance and About.

5.2.1 Overview

Log in the Web interface of UC120-1V1S10, click **Status** → **Overview**, and the following interface will be displayed. On the interface, device model, firmware version as well as information about performance, WAN network, VoLTE network, LAN network, WiFi and DHCP server are shown.

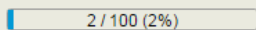
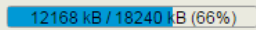
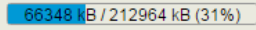
Figure 5-2 Overview

System Device Model UC120-1V1S10 Device SN D800-0520-1314-0001 Hardware ID 4834-1308-2823 Firmware Version 2.55.1.4 2019-10-11 22:30:58 CST +0800 Local Time 2019-10-16 20:57:37 Uptime 4 d 2 h 9 m 56 s Cloud Server Disabled		Performance CPU  Filesystem  Memory 	
WAN Network MAC Address F8-A0-3D-59-F7-1A Type Static IP Address 172.19.1.121 Netmask 255.255.255.0 Gateway 172.19.1.2 Preferred DNS server 0.0.0.0 Alternate DNS server - RX / TX (Per Second) 0 Bytes (0 Pkts.) / 0 Bytes (0 Pkts.) RX / TX (Total) 4.24 MB (37748 Pkts.) / 8.71 MB (169519 Pkts.)		VoLTE Network Module READY SIM Card SIM Not Inserted Mode Auto / Unknown / Unknown Carrier UNKNOWN Signal  IP Address 0.0.0.0 <input type="button" value="Connect"/> Preferred DNS server 0.0.0.0 Alternate DNS server - RX / TX (Per Second) 0 Bytes (0 Pkts.) / 0 Bytes (0 Pkts.) RX / TX (Total) 0.00 B (0 Pkts.) / 0.00 B (0 Pkts.)	
LAN Network MAC Address F8-A0-3D-59-F7-19 Type Static IP Address 192.168.11.1 Netmask 255.255.255.0 RX / TX (Per Second) 542 Bytes (4 Pkts.) / 318 Bytes (1 Pkts.) RX / TX (Total) 40.81 MB (212139 Pkts.) / 5.46 MB (11130 Pkts.)		DHCP Server Status Enabled Start Address 192.168.11.99 End Address 192.168.11.198 Gateway - Expires 12 Hours Preferred DNS server - Alternate DNS server -	

5.2.2 SIP

Click **Status** → **SIP**, and the following interface will be displayed. On the interface, information of SIP profile, SIP Trunk and SIP extension is shown.

Figure 5-3 Status of SIP Profile, SIP Trunk and SIP Extension

Index	Name	Listening Addr	State	Current Call	Call In(F/T)	Call Out(F/T)
1	lan_default	192.168.11.1:5060	RUNNING	0	0/0	0/0
2	wan_default	172.19.1.121:5080	RUNNING	0	0/0	0/0

Table 5-2 Explanation of SIP Parameters

Belong To	Parameter	Explanation
Profile	Name	The name of the SIP profile
	Listening Address	The current listening address and port of SIP
	State	Green color means normal running, while red color means listening address and port of SIP is unavailable. There are two states :Running and Down
SIP Trunk	Heartbeat	If heartbeat is enabled, option message will be sent to peer device (the peer device is reachable)
	Status	Green color means available, while red color means abnormal, unavailable or prohibited. There are five statuses: Running, Reged/Up, Noreg/Up, Trying-Down, Fail-Wait
	Profile	The profile that is used by the SIP trunk
SIP Extension	Profile	The profile that is used by the SIP extension
	Status	SIP extension is registered or not. There are two statuses: Registered. Unregistered

5.2.3 PSTN

On the **Status** → **PSTN** interface, information of FXS and FXO is shown. Green color means available or registered, while red color means abnormal, unregistered or prohibited.

Figure 5-4 Status of FXS and FXO

Status / PSTN							
FXS							
Port	Module State	Parameter Status	SIP Register Status	Hook State			
0	READY	OK	Not Config	ONHOOK			
FXO							
Port	Module State	Parameter Status	SIP Register Status	Hook State	Line State		
1	READY	OK	Not Config	ONHOOK	OFFLINE		
VoLTE							
Port	Module State	Channel State	Phone Number	SIP Register Status	Carrier	Signal	Talking State
2	READY	SIM Not Inserted	Unknown	Not Config	Unknown		IDLE

If 'SIP Register Status' is 'Registered', it means FXS and FXO have been **registered to SIP server** on the **Trunk** → **SIP/FXO** interface respectively. FXS can also be registered to SIP server on the **Extension** → **FXS** interface.

Table 5-2 Status Explanation of FXS and FXO

Belong To	Parameter	Explanation
FXS	Module Status	There are two module statuses: Ready and Config Failed
	Parameter Status	There are two parameter statuses: OK and error
	SIP Register Status	There are two SIP register statuses: Registered and Unregistered
	Hook State	There are two hook states: Onhook and Offhook
FXO	Module Status	There are two module statuses: Ready and Config Failed
	Parameter Status	There are two parameter statuses: OK and error
	SIP Register Status	There are two SIP register statuses: Registered and Unregistered
	Hook State	There are two hook states: Onhook and Offhook
	Line State	There are two hook states: Online and Offline
VoLTE	Channel State	The state of the VoLTE channel. If the VoLTE SIM card is successfully registered, it means the channel state is OK.
	Phone Number	The number of the VoLTE SIM card
	SIP Register Status	The register status of the VoLTE trunk in use
	Carrier	The carrier of the VoLTE SIM card
	Signal	The signal strength of the VoLTE SIM card
	Talking State	Whether the SIM card is on call or not

5.2.4 DHCP Client List

UC120-1V1S10 has a built-in DHCP server. When the DHCP server is enabled, it can assign IP addresses to the clients connected to it.

On the **Status → DHCP Client List** interface, information of DHCP clients connected to the UC120-1V1S10 gateway, such as client name, Mac address and IP address, is shown.

Figure 5-5 DHCP Client List

Status / DHCP Client List					
ID	Client Name	MAC Address	IP Address	Expiration	Status
1	GJFdeiphone	6C:8D:C1:05:A5:EE	192.168.11.173	2016-09-12 19:49:46	Online

5.2.5 Fail2ban

On the **Status → Fail2ban** interface, you can see currently-banned IP addresses and historic banned IP addresses. You can also unban those IP addresses that have been blocked before.

Fail2ban is a log-parsing application that monitors system logs for symptoms of an automated attack on your device. When an attempted compromise is located, using the defined parameters, Fail2ban will add a new rule to block the IP address of the attacker, either for a set amount of time or permanently. Fail2ban can also alert you through email that an attack is occurring.

Figure 5-6 Banned IP Addresses

Status / Fail2ban					
Current Ban List					
Index	IP	Ban time	Release time	Type	Action
Operation History List					
Index	IP	Common Ban Duration	Type	Action	Operation time
					<input type="button" value="Filter"/>

For the explanation of parameters related to fail2ban, please refer to the “Network ->Fail2ban” section.

5.2.6 VPN

On the **Status → VPN** interface, the online records and historical records of UC120-1V1S10 as a L2TP client, a PPTP client and an OpenVPN client are displayed.

Meanwhile, the UC120-1V1S10 gateway can also serve as a VPN server, such as L2TP server, PPTP server and OpenVPN server. Related online records and historical records are shown on the **Status → VPN ->OpenVPN Server** or **Status -> VPN -> L2TP/PPTP Server Access List** interface.

Figure 5-7 VPN Connection Records

Status / VPN

OpenVPN Client OpenVPN Server L2TP Client PPTP Client L2TP/PPTP Server Access List

Online Record

Index	Protocol	IP Address	Gateway	Server Address	RX / TX Bytes	Login Time	Connection Time
This section contains no records yet							

History Records

Index	Protocol	IP Address	Gateway	Server Address	RX / TX Bytes	Login Time	Connection Time	Filter
This section contains no records yet								

5.2.7 Current Call

On **Status** → **Current Call** interface, the source, destination, calling number, called number, start time, answer time, state and duration of the current real-time call are shown. If there is no current call, no information will be shown

Figure 5-8 Current Call Information

Status / Current Call

Index	Src	Dest	Caller	Called	Start Time	Answer Time	State	Duration	Filter
-------	-----	------	--------	--------	------------	-------------	-------	----------	--------

5.2.8 Parking Lot

You can use the parking feature to park a call, and then retrieve the call either from your phone or another phone. After you park a call, the call is placed on hold, you can continue the conversation after retrieving it.

On the **Status** → **Parking Lot** interface, the numbers that are parked and the parking duration are shown.

Figure 5-9 Call Parking Status

Status / Parking Lot

Index	Parking Number	Source	Duration
-------	----------------	--------	----------

5.2.9 CDRs

Click **Status** → **CDRs**, and you can set query criteria to query the CDRs (Call Detailed Records) that you want on the displayed interface. Meanwhile, you are allowed to clear CDRs or export CDRs through clicking the **Empty** or **Export** button. The maximum number of CDRs that can be saved is 5000.

CDRs cannot be saved on the **Status** → **CDRs** interface unless the CDRs function has been enabled on the **System** → **Setting** interface.

Figure 5-10 CDRs

The screenshot shows the 'Status / CDRs' interface. It includes a 'CDRs Query Param' section with fields for Start Date (2019-11-1), End Date (2019-11-29), Caller, Called, Source (Any), Destination (Any), Min Duration, and Max Duration. There are 'Query' and 'Reset' buttons. Below is a 'CDRs List' section with 'Empty' and 'Export' buttons. The table below shows the data from the CDRs list.

Index	Caller	Source	Called	Destination	Start Time	End Time	Duration	Hangup By	Codec	Hangup Cause	Filter
1	8000	FXS Extensi...	*158		2019-10-12 18:22:25	2019-10-12...	7	Caller	PCMA	Normal Clearing	
2	8000	FXS Extensi...	*158	*158	2019-10-12 18:19:35	2019-10-12...	8	Caller	PCMA	Normal Clearing	
3	8000	FXS Extensi...	*158	*158	2019-10-12 18:14:28	2019-10-12...	8	Caller	PCMA	Normal Clearing	
4	8000	FXS Extensi...	*158	*158	2019-10-12 18:12:09	2019-10-12...	9	Caller	PCMA	Normal Clearing	

5.2.10 Service

Click **Status** → **Service**, and the service status of UC120-1V1S10 is displayed. This function is enabled by default. The Web, SSH and Telnet service can be disabled and their ports can be modified on the **Network** → **Access Control** interface. If no running status is shown, it means exception has occurred on UC120.

Besides, if syslog is disabled on the **System** → **Setting** interface, the logs cannot be uploaded to the server, but log service is still running.

Figure 5-11 Service Status

The screenshot shows the 'Status / Service' interface. It displays a list of services and their status:

- Msg Service: Running
- Switch Kernel Service: Running
- Log Service: Running
- Upgrade Service: Running
- Web: Running
- SSH: Running
- Telnet: Stopped
- Remote Proxy: Stopped
- NATS Server: Stopped

5.2.11 Performance

On the Status → Performance Interface, you can see the performance statistics of the system.

Figure 5-12 System Performance

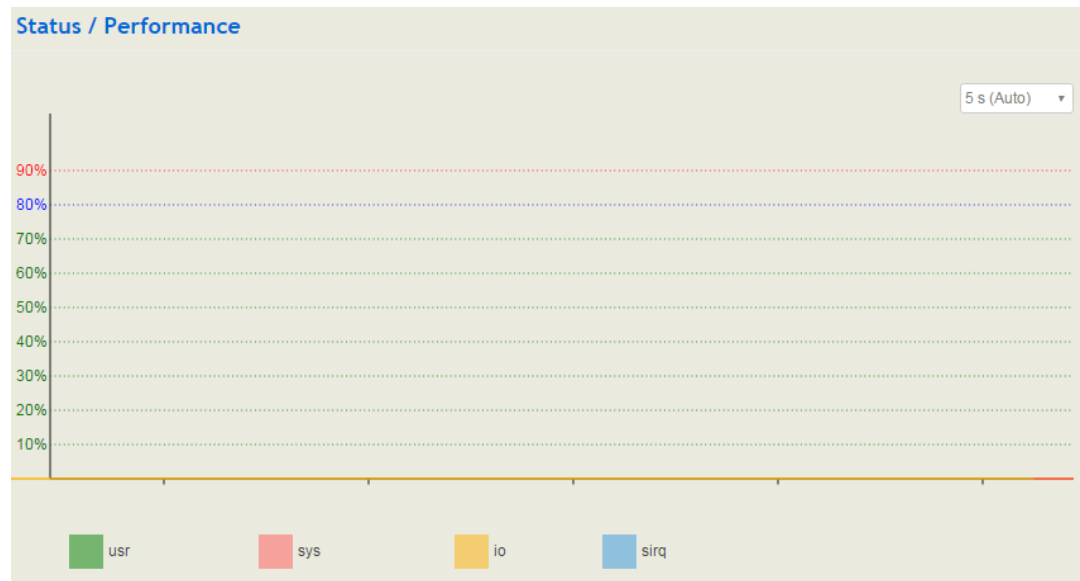

5.2.12 About

On the **Status** → **About** page, the device model, device SN, hardware ID, MAC address, IMEI, VoLTE module, boot image, root image, WIFI driver, firmware Version of the UC120-1V1S1O device are displayed.

Figure 5-13 Device and Company Information

Status / About

Copyright

DINSTAR

www.dinstar.com
Tel: 86-755-26456664/61919966
Copyright © Dinstar Technologies Co., Ltd. All Rights Reserved.

System

Device Model	UC120-1V1S1O
Device SN	D800-0520-1314-0001
Hardware ID	4834-1308-2823
MAC Address	F8-A0-3D-59-F7-19
Boot Image	9
IMEI	866758042582623
VoLTE Module	EC25EFAR06A03M4G
Root Image	13
Firmware Version	2.55.1.4 2019-10-11 22:30:58 CST +0800

5.3 System

Configurations for hostname, timezone, NTP, login username & password, other user name, provision, TR069, operation log, service log, upgrade/backup/restore, IVR upload, Command Line, cloud server and device reboot can be carried out in the System section.

5.3.1 Setting



On the **System** → **Setting** interface, you can modify the device name, set a new timezone, synchronize local time and enable CDRs, Syslog as well as built-in NTP server.

Figure 5-12 Basic Setting

The screenshot displays the 'System / Setting' web interface. It is organized into three main sections: 'General', 'Log', and 'Time Synchronization'.
General Section:
 - Hostname: UC120
 - Language: English
 - Timezone: UTC
 - Local Time: 2019-11-29 09:40:39, with a 'Sync with browser' button.
 - Date Format: YYYY-MM-DD
 - CDRs: Enable
Log Section:
 - Service Log Level: Notice
 - Enable Syslog:
Time Synchronization Section:
 - Enable builtin NTP server:
 - NTP server candidates: A list of four entries: 0.pool.ntp.org, 1.pool.ntp.org, 2.pool.ntp.org, and 3.pool.ntp.org. Each entry has a red 'X' icon, and the last entry (3.pool.ntp.org) also has a green '+' icon.
 At the bottom of the interface are three buttons: 'Cancel', 'Save', and 'Reset'.

Figure 5-4 Explanation of Basic Setting Parameters

Parameter	Explanation
Hostname	The name of the gateway. After it is configured, the name will be displayed on the left of the menu bar.

Timezone	You can choose a time zone you want. The default value is UTC (Universal Time Coordinated)
Local Time	The current time based on current time zone. It is synchronized with NTP.
CDRs	If it is enabled, CDRs will be saved automatically. 5000 CDRs call be saved at most and they can be queried on the Status → CDRs interface. If it is disabled, CDRs will not be saved
Service Log Level	There are eight levels, including Debug, Info, Notify, Warning, Error, Critical, Alert and Emergency
Enable Syslog	Whether to enable syslog
Time Synchronization	If NTP server is enabled, the UC120-1V1S10 can be synchronized with the world standard time. Meanwhile, you're able to add or reduce NTP servers. Please consult local telecom operators or surf the internet for the address of NTP servers.
	Delete a NTP Server
	Add a NTP Server

5.3.2 User Manager

Click **System → User Manager**, and you can modify the username name and password for logging in the UC120-1V1S10 gateway. Factory defaults for username name and password are admin and admin@123# respectively, so it is advised to modify them for security consideration.

The abovementioned username and password are also used to log in Web Interface, Telnet and SSH.

The super administrator of the device can add different users to the device and assign different roles for them, like observer, operator and administrator. Different roles can be allocated with different permissions to the functions.

Figure 5-14 Modify Username ,Password and Manager Users

System / User Manager

Modify Password

Current Username

Old Password

New Password

Confirm New Password

Other User Manager

Username	User Group	Expiration	Description	Status
This section contains no values yet				

Figure 5-15 Add New User

System / User Manager / New User

Name

User Group

New Password

Confirm New Password

Expiration

Description

Status

Web Access Permission

Status View

System View

Network View

Profile View

Extension View

Trunk View

Call Control View

Figure 5-5 Explanation of Provision Parameters

Parameter	Explanation
Name	The name of the new user. After it is established, the name and the password will be used to log into the web page of the device.
User Group	You can choose a role for the new user, such as administrator, operator and observer. The default value is administrator.

New Password	Setting the login password for the new user. The password needs to consist of 8 to 32 characters.
Expiration	The expiry date when the user cannot log in the device any more.
Status	Choose enable or disable.
Web Access Permission	The permissions to view status, system, network, profile, extension, trunk and call control.

5.3.3 Provision

Provision is used to make UC120-1V1S10 automatically upgrade with the latest firmware stored on an http server, an ftp server or a tftp server.

As for how to configure UC120-1V1S10 and http/ftp/tftp server for Provision, please make reference to the instruction guide of Provision.

Select the checkbox on the right of **Enable**, and you will see the following interface:

Figure 5-16 Provision

Table 5-6 Explanation of Provision Parameters

Parameter	Explanation
Periodic Check	Whether to enable periodic check. If it is enabled, the gateway will automatically check whether the firmware version stored on the URL is

	updated.
Check Interval	The interval to check whether the firmware version stored on the URL is updated. If it is 3600s, the gateway will check every 3600s.
URL	The URL of the http/ftp/tftp server: For example: ftp://172.16.77.200/home tftp://172.16.77.200/provision.xml http://test.domain.com/test
Username	The login username of the http/ftp/tftp server
Password	The login password of the http/ftp/tftp server

Note: Proxy Address, Proxy Username and Proxy Password are optional to be configured.

5.3.4 Operation Log

The logs tracing the operations carried out on the Web can be queried on the **System** → **Operation Log** interface. You are allowed to set query criteria to query the logs that you want and to export the logs through clicking the **Export** button at the top-right corner.

Figure 5-17 Operation Logs

Index	Time	Level	Access Source	Operation	Page
100	2019-11-29 Fri 09:58:42	Info	172.19.1.11:52650	View	system/provision
99	2019-11-29 Fri 09:52:09	Info	172.19.1.11:52549	Add New Config	system/security/user/add
98	2019-11-29 Fri 09:49:05	Info	172.28.69.117:62291	View	
97	2019-11-29 Fri 09:43:52	Info	172.19.1.11:52415	Add New Config	system/security/user/add
96	2019-11-29 Fri 09:42:01	Info	172.19.1.11:52358	View	system/security
95	2019-11-29 Fri 09:40:21	Info	172.19.1.11:52356	View	system/setting
94	2019-11-29 Fri 09:39:05	Info	172.28.69.117:62173	View	status/overview
93	2019-11-29 Fri 09:39:03	Info	172.28.69.117:62173	View	status/pstnstatus
92	2019-11-29 Fri 09:38:58	Info	172.28.69.117:62171	View	status/overview
91	2019-11-29 Fri 09:38:56	Info	172.28.69.117:62171	View	status/sipstatus
90	2019-11-29 Fri 09:38:48	Info	172.28.69.117:62161	View	network/access_control
89	2019-11-29 Fri 09:38:23	Info	172.28.69.117:62162	View	
88	2019-11-29 Fri 09:38:23	Info	172.28.69.117:62162	Login Succ	
87	2019-11-29 Fri 09:38:17	Info	172.28.69.117:62155	View	
86	2019-11-29 Fri 09:38:05	Info	172.19.1.11:52312	View	status/about
85	2019-11-29 Fri 09:37:53	Info	172.19.1.11:52311	View	
84	2019-11-29 Fri 09:37:53	Info	172.19.1.11:52311	Login Succ	

Note: Operation logs are generally used to locate faults by device manufacturer.

5.3.5 Service Log

Service logs (the running logs of UC120-1V1S10) can be exported on the **System → Service Log** interface. Those logs are used for analyzing where a problem has occurred on the gateway.

Figure 5-18 Service Log

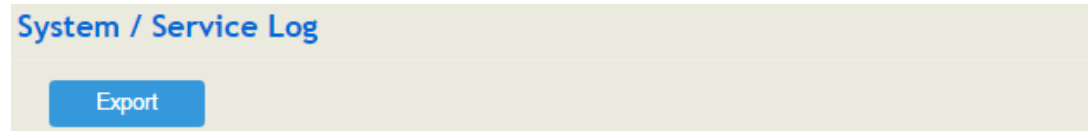

5.3.6 Config Changes Log

On the **System → Config Changes Log** interface, the configurations changed by administrator on the Web of the gateway are recorded.

Figure 5-19 Config Changes Log



5.3.7 Backup/Restore/Upgrade

On the **System → Backup/Restore/Upgrade** interface, you can back up or restore configuration data, and can upgrade UC120 to a new version. But you need to restart the device for the change to take effect after executing restore or upgrade.

Figure 5-19 Backup/Restore/Upgrade

Figure 5-20 Upgrade the Device

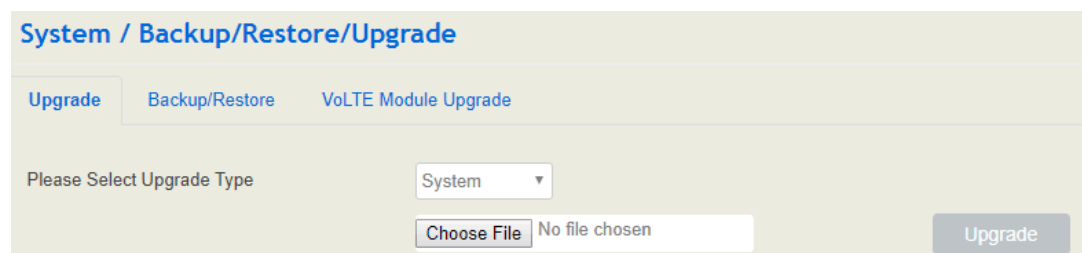

Note: the file you choose to be upgraded on the above interface is a local file, while the version file upgraded through the Provision function is a file from http/ftp/tftp server.

Figure 5-21 Back up configurations

System / Backup/Restore/Upgrade

Upgrade Backup/Restore VoLTE Module Upgrade

Choose backup files and download System Network Service **Download**

Reset to defaults System Network Service **Reset**

Restore from the backup **Choose File** No file chosen **Restore**

Restore to History Backup

Index	User	Backup Time	
1	admin	2019-10-12 19:01:05	
2	admin	2019-10-12 18:48:13	

Figure 5-22 Upgrade VoLTE module

System / Backup/Restore/Upgrade

Upgrade Backup/Restore VoLTE Module Upgrade

Please Select Module Type SIMCOM_SIM7600CE-T

Please Upload File **Choose File** No file chosen **Upgrade**

Port	Module	Software Version	Module State	Upgrade Progress
------	--------	------------------	--------------	------------------

Table 5-7 Explanation of Backup/Restore/Upgrade Button

Download	You can download the configuration data to be backed up. Select any of the checkboxes on the left of System, Network and Service, and then click Download
Reset	Select any of the checkboxes on the left of System, Network and Service, and then click Reset , and configurations related to the selected part will be restored to factory defaults.
Restore	Choose a backup file, and then click Restore .
Upgrade	Choose a file to be upgraded (which is provided by Shenzhen Dinstar Co., Ltd.), and then click Upgrade .

5.3.8 Voice

On the **System → Voice** interface, you can upload an IVR file according to your needs. At present, only wav audio file is allowed. The format of the uploaded wav audio file must be: monaural, 8000hz, 16bit, and size of no more than 1M.

Figure 5-23 Upload IVR File

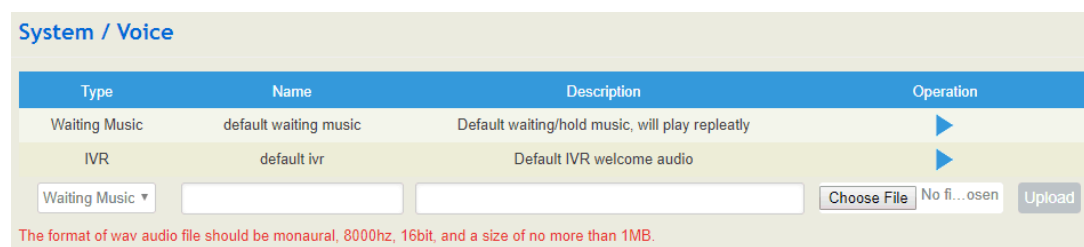

5.3.9 Command Line

On the **System → Command Line** interface, some commonly-used command lines can be directly selected in the draw-down box, and therefore user has no need to enter command lines on Telnet. In this way, the efficiency of problem diagnostics is greatly improved.

Commonly-used command lines include fxo config, fxo status, fxs config, fxs status, gsm status, gsm bcch, gsm oper, sip status, sip profile and so on.

Figure 5-24 Command Line

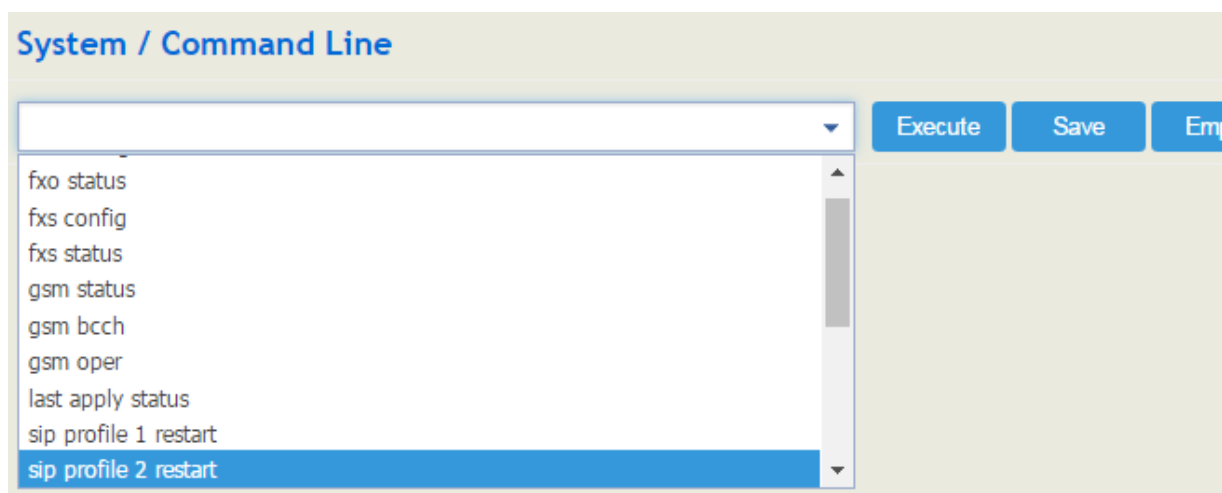

5.3.10 Diagnostics

Use a telephone line to connect the FXS port and the FXO port, and then insert an SIM card. On the **System → Diagnostics** interface, select a module (FXS/FXO or LTE) that you want to diagnose. Click Start, and the gateway will begin to diagnose the selected module(s).

If the progress bar of diagnostics is green, it means the module that is diagnosed works well; if the progress bar is red, it means the module that is diagnosed is faulty.

Figure 5-25 Diagnostics

System / Diagnostics

Module Diagnostics

Select the module you want to diagnostics FXS/FXO SIM Voice SIM Internet

FXS/FXO FXO online detected ! Make sure that the FXO is connected to the local FXS port !

SIM Voice Please insert SIM card !

SIM Internet Please insert SIM card !

5.3.11 Cloud Service

Cloud service is mainly used to centrally manage all kinds of devices. Through cloud service, you can query the status of a device, upgrade devices at batch, log in or configure a device remotely. The UC120-1V1S1O gateway provides Cloud service. Enter the IP address, service port and password of the Cloud server, and then the gateway will connect to the cloud server.

Figure 5-26 Cloud Server

System / Cloud Service

Remote Proxy NATS Server

Status

Server Address

Server Port

Password

NATS Server:

UC120-1V1S1O can work as a NATS client to send messages to a NATS server, and then the NATS server will open related ports to facilitate the connection with those clients or servers of users.

Working Principle:

5.3.12 API

UC120 provides API (Application Programming Interface) to interwork with other devices or platforms. This function enables you to centrally manage devices through command lines.

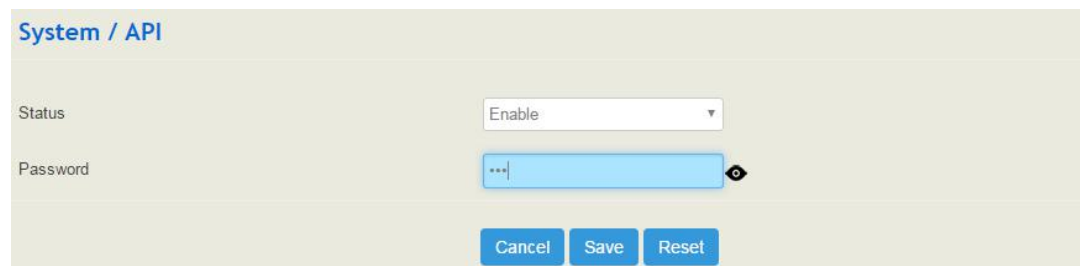

The screenshot shows a web interface for configuring the API. The title is 'System / API'. There are two main fields: 'Status' with a dropdown menu currently showing 'Enable', and 'Password' with a text input field containing three asterisks. At the bottom of the form are three buttons: 'Cancel', 'Save', and 'Reset'.

5.3.13 Event Report

UC120-1V1S1O allows the following events to be reported through NATS or URL: device startup, call status, registering or unregistering of SIP extensions, availability or unavailability of SIP trunks, off-hook or on-hook of FXS phone, FXO status and update of CDR information.

For event report through NATS, please refer to the configuration steps of NATS in the Cloud Server section.

For event report through URL, please see the following example:

1. Select the event that is to be reported and the way to report the event (URL);
2. Input the URL.

Format: [http://ip:port/event?key1=\\$value1&key2=\\$value2](http://ip:port/event?key1=$value1&key2=$value2)

[http://172.18.111.65:8080/sip?sn=\\$sn&mac=\\$username&key=\\$sip_status](http://172.18.111.65:8080/sip?sn=$sn&mac=$username&key=$sip_status)

Event refers to startup, callstatus, sip, siptrunk, fxs, fxo, gsm, volte, vpn and cdr, while value refers to the parameter that needs to be reported. Key can be defined by yourself, but it's generally the same with value.

Figure 5-27 Input URL

The screenshot shows the 'System / Event Report' web interface. The 'SIP' tab is selected. Under 'Event Type', the 'URL Report' checkbox is checked, and a text input field contains the URL: `http://172.18.111.65:8080/sip?sn=$sn&mac=$susername&key=$sip_status`. Below this, a 'Parameter List' section defines variables: `$susername` (Username), `$network_address` (SIP Extension Register Address, IP:Port), `$agent` (SIP Agent), `$sip_status` (SIP Extension Status, REGISTER/UNREGISTER), `$sn` (Device SN), `$mac` (MAC Address), `$ip` (WAN IP address(Route Mode) or LAN IP address(Bridge Mode)), `$key` (Security Code), `$time` (Local Date/Time, YYYY-MM-DD HH:MM:SS), and `$epochtime` (Unix epoch time). Other options like 'SIP Extension Register/Unregister', 'Json Format', 'NATS Report', and 'SIP Trunk Available/Unavailable' are also visible with their respective checkboxes.

3. Use a softphone to register to an extension of UC120-1V1S10, and then the registering of unregistering of the softphone will be reported to UC120 through URL.
4. On the **System**→**Event Report**→**Log** interface, you can view the report information.

5.3.14 Schedul Task

On the **System** → **Schedule Task** interface, you can set a scheduled time to reboot the UC120 device, record backup, access SIM internet, and back up CDRs, logs or configurations.

Figure 5-28 Configure scheduled task

The screenshot shows the 'System / Schedule Task' web interface. The 'Config Backup' tab is selected. The 'Status' dropdown is set to 'Enable'. The 'Interval' is set to '1' Day. The 'Execution Time' is set to '0' Hour and '5' Min. There are checkboxes for 'Local Backup' and 'Backup to Server', both of which are currently unchecked. At the bottom, there are 'Save' and 'Reset' buttons.

5.3.15 Email

On the **System → Email** interface, you can configure a email client on UC120, which can be used to send or receive emails. The email client can also used to test connection. But on top of that, SMTP, IMAP and POP 3 services need to be enabled for the email client.

When the email client is used with SMS routing, email and SMS are bound, which brings great convenience, for example, you can receive an email , although someone is sending you an SMS message. Meanwhile, logs will be generated can be viewed on the **System → Email → Log** interface.

Figure 5-29 Configure Email Client

The screenshot displays the 'System / Email' configuration page. It features two tabs: 'Configuration' (selected) and 'Log'. The main configuration area is divided into three sections: 'Status', 'Send(SMTP)', and 'Receive'.

- Status:** A dropdown menu is set to 'Enable'. Below it, the 'Username' field contains 'admin123' and the 'Password' field is masked with dots. A 'Connect Test' button is present, along with checkboxes for 'Send' and 'Receive'.
- Send(SMTP):** This section includes fields for 'Server Address', 'Port' (set to 465), 'TLS Enable' (checked), and 'Email Address'.
- Receive:** This section includes fields for 'Protocol' (set to IMAP), 'Server Address', 'Port' (set to 993), 'TLS Enable' (checked), 'Folder' (set to INBOX), 'Message Query Interval(min)' (set to 5), 'Message Valid Time Range' (set to Within 5 minutes), and 'Numbers of Message Per Receive' (set to 5).

Username	Enter the address of email client
password	The password or authorization code of the email client
Server Address	The Address of the SMTP server, supported by the email client
Protocol	Choose IMAP or POP3. When POPS is selected, TLS port is 995 by default.
Message Query Interval (min)	The time interval to check whether there is a new email.
Message Valid Time Range	Only those emails received during this time range are addressed.
Number of Message Per Receive	The maximum number of emails that are received at one time. If the number exceeds, they will be received in batches.

5.3.16 FTP Server

On the **System → FTP Server** interface, you can enable the FTP server function of UC120 and configure related parameters such as username, password and access permissions. You can connect FTP clients to this FTP server and then access those files (like recording files and system logs) that are open on the UC120 device through the 21 port.

Figure 5-30 Configure FTP Server

The screenshot displays the 'System / FTP Server' configuration page. It features a breadcrumb trail 'System / FTP Server' and two tabs: 'FTP Server' (active) and 'Log'. The configuration area contains several fields: 'Status' is a dropdown menu set to 'Enable'; 'Username' is a text input field containing 'admin123'; 'Password' is a masked text input field with a visibility toggle icon; 'Allow user to delete files' is a dropdown menu set to 'Disable'; 'TLS Verification' is a dropdown menu set to 'Disable'; 'Allow WAN access' is a dropdown menu set to 'Enable'; and 'Time Period' is an empty text input field. At the bottom of the configuration area, there are three buttons: 'Cancel', 'Save', and 'Reset'.

5.3.17 Disk Manager

On the **System → Disk Manager** interface, you can see the memory usage of USB and SD card. USB memory are divided into three categories, including voicemail(40%), recording

(50%) and Others(10%). You can also redevide the proportion of each category, disconnect the USB or execute formatting on this interface.

Figure 5-31 Disk Manager

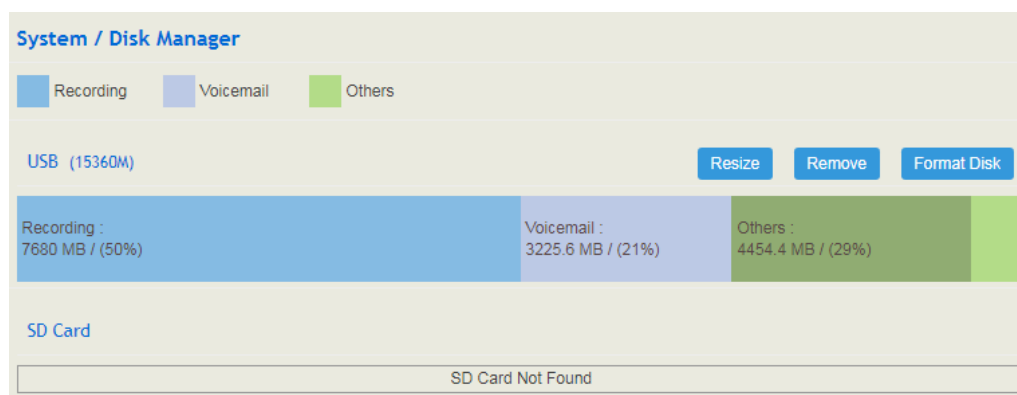

Note: UC120 only supports USB of FAT and EXT4.

5.3.18 Reboot

On the **System** → **Reboot** interface, you can click **Perform Reboot** to reboot the UC120-1V1S10 gateway. After the device is rebooted, those configurations that have been saved will remain unchanged.

Figure 5-32 Reboot Device

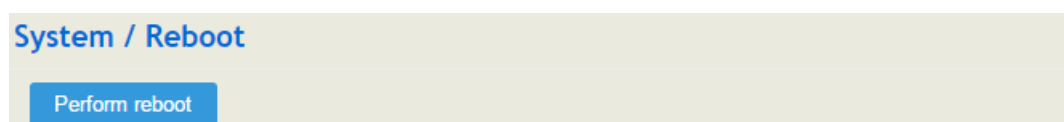

5.4 Network

UC120-1V1S10 works in two modes: route mode and bridge mode. When it is under the route mode, the IP of WAN must be different from the IP of LAN. But when it is under the bridge mode, the IP of WAN and the IP of LAN are the same.

5.4.1 Setting

On the **Network** → **Setting** interface, you can set the IP address of WAN port and LAN port, and can turn on WiFi.

Under the route mode, the default IP address of WAN port is a DHCP IP address, while the default IP address of the LAN port is 192.168.11.1.

In fact, there are three kinds of IP addresses for selection for WAN port and LAN port, including Static IP address, DHCP and PPPOE.

DHCP: Obtain IP address automatically.

UC120-1V1S10 is regarded as a DHCP client, which sends a broadcast request and looks for a DHCP server to answer. Then the DHCP server automatically assigns an IP address to the UC120-1V1S10 from a defined range of numbers.

Figure 5-33 Default IP Address under Route Mode

The screenshot shows the 'Network / Setting' web interface. The 'Network Model' is set to 'Route'. Under the 'WAN' section, the 'Protocol' is set to 'DHCP', and the checkboxes for 'Obtain DNS server address automatically' and 'Disable Private Internets(RFC2918) DNS responses' are checked. The 'MTU' is set to 1500. Under the 'LAN' section, the 'IP Address' is 192.168.11.1, the 'Netmask' is 255.255.255.0, and the 'MTU' is 1500. At the bottom, there are 'Cancel', 'Save', and 'Reset' buttons.

Figure 5-34 Set WAN IP as DHCP IP

The screenshot shows the 'WAN' configuration section of the 'Network / Setting' web interface. The 'Protocol' is set to 'DHCP', and the checkboxes for 'Obtain DNS server address automatically' and 'Disable Private Internets(RFC2918) DNS responses' are checked. The 'MTU' is set to 1500.

Note: When WAN IP is set as DHCP IP, please ensure that there is DHCP server working normally in the network.

Static IP Address:

Static IP address is a semi-permanent IP address and remains associated with a single computer over an extended period of time. This differs from a dynamic IP address, which is assigned *ad hoc* at the start of each session, normally changing from one session to the next.

If you choose static IP address, you need to fill in the following information:

- IP Address: the IP address of the WAN port of the UC120-1V1S10;
- Netmask: the netmask of the router connected the UC120-1V1S10;
- Default Gateway: the IP address of the router connected the UC120-1V1S10;
- Use custom DNS server: the IP address of the DNS server

Figure 5-35 Set WAN IP as Static Address



The screenshot shows the WAN configuration interface. The 'Protocol' dropdown menu is set to 'Static address'. The 'IP Address' field contains '172.16.80.117'. The 'Netmask' dropdown menu is set to '255.255.0.0'. The 'Default Gateway' field contains '172.16.1.7'. The 'Use custom DNS server' field contains '202.96.128.166'.

WAN	
Protocol	Static address
IP Address	172.16.80.117
Netmask	255.255.0.0
Default Gateway	172.16.1.7
Use custom DNS server	202.96.128.166

PPPoE:

PPPoE is an acronym for point-to-point protocol over Ethernet, which relies on two widely accepted standards: PPP and Ethernet. PPPoE is a specification for connecting the users on an Ethernet to the Internet through a common broadband medium, such as a single DSL line, wireless device or cable modem. PPPOE IP address refers to IP address assigned through the PPPoE mode.

If you choose PPPoE, you need to fill in to fill in the following information:

- Username: the account name of PPPoE
- Password: the password of PPPoE
- Server Name: the name of the server where PPPoE is placed

Figure 5-36 Set WAN IP as PPPoE IP

The screenshot shows the WAN configuration interface. The 'Protocol' is set to 'PPPOE'. The 'Username' is 'admin' and the 'Password' is masked with dots. The 'Server Name' field is empty. The 'Obtain DNS server address automatically' and 'Disable Private Internets(RFC2918) DNS responses' options are checked. The 'MTU' is set to 1500.

WAN	
Protocol	PPPOE
Username	admin
Password	*****
Server Name	
Obtain DNS server address automatically	<input checked="" type="checkbox"/>
Disable Private Internets(RFC2918) DNS responses	<input checked="" type="checkbox"/>
MTU	1500

5.4.2 VoLTE

On the **Network** → **VoLTE** page, you can enable the VoLTE service, and fill in information of APN, username, password, mode, PIN code, dial number and so on.

Figure 5-32 VoLTE Config

The screenshot shows the 'Network / VoLTE Config' page. The 'Current Mode' is '4G'. The 'Status' is 'Enabled'. The 'APN' is 'cmnet'. The 'Username' is 'admin' and the 'Password' is masked with dots. The 'Mode' is 'Auto'. The 'PIN Code' field is empty. The 'Dial Number' is '*99#'. The 'Service' is 'umts'. There are 'Cancel', 'Save', and 'Reset' buttons at the bottom.

Current Mode	4G
Status	Enabled
APN	cmnet
Username	admin
Password	*****
Mode	Auto
PIN Code	
Dial Number	*99#
Service	umts

Table 5-10 Explanation of Parameters for VoLTE Config

Current Mode	4G
Status	The LTE module is enabled or not.

	There are two statuses: Enabled. Disabled
APN	The name of access point, you can select 3GNET. Cmnet or custom.
Username	The name of VoLTE module, used to access network
Password	The password of VoLTE module, used to access network
Mode	The mobile network has 2g & 3g, 4g, or automatic configuration.
PIN Code	The SIM card's personal identification number.
Dial Number	The LTE network's dialing number.
Service	The LTE service type is UMTS.

5.4.3 Uplink Config

On the **Network → Uplink Config** page, you can configure an uplink strategy based on the priority between WAN and VoLTE. The "WAN Master, VoLTE Slave" means that the data from the UC120-1V1S10 will be transmitted through the WAN port, and when the WAN fails, the data will be transmitted through LTE, while the "VoLTE Master, WAN Slave" is the opposite.

Figure 5-37 Uplink Configuration

Network / Uplink Config

Uplink Strategy

WAN

Track IP

Ping Count

Timeout(s)

Interval(s)

Count of Down

Count of Up

VoLTE

Track IP

Ping Count

Timeout(s)

Interval(s)

Count of Down

Count of Up

Table 5-11 Explanation of Parameters for Uplink Config

Uplink Strategy	WAN Master,LTE Slave or LTE Master,WAN Slave
Track IP	A WAN (or LTE) tracking IP address (which can be more than one), when this address is not available, it is thought that the network of WAN (or LTE) is not available, switching to LTE (or WAN). If this IP is 0.0.0.0, it means the current configured DNS address and gateway is being tracked by PING .
Ping Count	The times of checking IP addresses by PING.

Timeout(s)	If the Ping does not respond during the timeout period, it is thought as a connection failure. For example, the timeout period is set as 2 seconds, which means if there is no response after the IP is checked by Ping for 2 seconds, it is a connection failure
Interval(s)	The interval for the device to check IP address by PING
Count of Down	The number of consecutive failures (by PING), if this value is reached, it means the network connection fails
Count of Up	The number of consecutive successes (by PING), if this value is reached, it means the network is available

5.4.4 Access Control

The access ports of Web, Telnet and SSH, as well as relevant on-off controls, can be configured on the **Network → Access Control** interface.

Figure 5-38 Access Control

Network / Access Control

Web Server

HTTP

Enable

HTTP Port

Allow WAN access

HTTPS Port

Allow WAN access

Telnet

Enable

SSH

Enable

Cancel Save Reset

5.4.5 Firewall

If the UC120-1V1S10 works under the route mode, you can choose to enable the firewall and set filter rules to accept or reject certain destination IP addresses.

Configuration Procedures:

1. Select **On** in the drop-down box on the right of **Filter Rules Control**
2. Select filter action, accept or reject;
3. Click the **New** button;
4. Fill in information of filter rule;
5. Click the **Save** button to save the configuration.

Figure 5-39 Firewall

Network / Firewall

Filter Rules Control: On

Default action outside the filter rules: ACCEPT

Filter Rules

Index	Name	Protocol	LAN IP/Port/MAC	WAN IP/Port	Action
1	abc	TCP	192.16.11.1/*	172.16.80.117/1	Accept

Buttons: New, Save, Edit, Delete

Note:



: Edit information for the corresponding filter rule.



: Delete the corresponding filter rule.

/*: Information of Source or Destination is not completely filled in.

Figure 5-40 Create Filter Rule

Network / Firewall / Filter Rules / New

Index	1 ▼
Name	Filter Rule-1
Protocol	TCP ▼
LAN IP	
LAN Port	
LAN MAC	00:00:00:00:00:00
WAN IP	
WAN Port	
Action	Accept ▼

Cancel Save Reset

Table 5-12 Explanation of Parameters for Filter Rule

LAN IP	The IP address that you want UC120 to accept or reject. It is the IP address of a host from local-area network; it can also be a string of IP addresses, for example, 172.16.11.1/15.
LAN Port	The port of LAN host which the accepted or rejected IP address belongs to
LAN MAC	The Mac of the LAN host twchich the accepted or rejected IP address belongs to
WAN IP	The IP address that you want UC120 to accept or reject. It is the IP address of a host from wide-area network; it can also be a string of IP addresses, for example, 152.16.11.11/19.
WAN Port	The port of WAN host which the accepted or rejected IP address belongs to
Action	Choose accept ot reject

5.4.6 DHCP Server

If there is a need, you can choose to enable the built-in DHCP server of UC120-1V1S10 to assign IP addresses to PC or other clients that are in the same local-area network with UC120. Under this condition, the UC120-1V1S10 gateway works like a router.

Figure 5-41 Enable DHCP Server

Network / DHCP

DHCP Server: Enable

Start Address: 192.168.11.99

End Address: 192.168.11.198

Leasetime(Hour): 12

Gateway:

Master DNS:

Slave DNS:

Buttons: Cancel, Save, Reset

Table 5-13 Explanation of Parameters for DHCP Server

Start Address	The start IP address of the address pool to be assigned
End Address	The end IP address of the address pool to be assigned
Lease Time	The validity period of the assigned IP address
Gateway	The gateway of the IP address pool to to be assigned, it is optional to fill in
Master DNS	The master DNS of the client whose IP address is assigned by the built-in DHCP server; it is optional to fill in
Slave DNS	The slave DNS of the client whose IP address is assigned by the built-in DHCP server; it is optional to fill in

5.4.7 Port Mapping

When the UC120-1V1S10 works under the route mode, port mapping allows a client in the wide-area network to visit a client in the local-area network.

Configuration Procedures:

1. Click **Network** → **Port Mapping**, and the following interface will be shown.

Figure 5-42 Port Mapping

Index	Name	WAN Port	Protocol	LAN IP	LAN Port	Status
This section contains no values yet						

2. Click the **New** button.
3. Fill in information on the following interface.

Figure 5-43 Create New Port Mapping

Table 5-14 Explanation of Parameters for Port Mapping

Name	The name of this port mapping
WAN Port	The port of the client in the wide-area network, which is to visit local-area network
Protocol	Choose TCP, UDP or TCP/UDP
LAN IP	The IP address of the to-be-visited client in local-area network
LAN Port	The port of the to-be-visited client in local-area network (this port cannot conflict with the port of UC120-1G1S10)
Status	Chose enable or disable.

4. Click the **Save** button to save the above configurations.

5.4.8 DMZ Setting

When the UC120-1V1S10 gateway works under the route mode and the DMZ service is enabled, the clients in the wide-area network are allowed to have direct access to the clients in the DMZ (**demilitarized zone**).

Figure 5-44 Enable DMZ Service

The screenshot shows the 'Network / DMZ' configuration page. It features a 'DMZ Status' dropdown menu set to 'Enabled' and a 'DMZ IP Address' text input field containing '192.168.1.123'. At the bottom of the form, there are three buttons: 'Cancel', 'Save', and 'Reset'.

5.4.9 Diagnostics

On the **Network** → **Diagnostics** interface, you can use three network utilities including Ping, Traceroute and Nslookup to diagnose the network, and can capture data packages of the available network ports.

Figure 5-45 Network Diagnostics

The screenshot displays the 'Network / Diagnostics' interface. Under the 'Network Utilities' section, there are three buttons: 'Ping', 'Traceroute', and 'Nslookup', each with an adjacent empty text input field. The 'Network Capture' section includes several configuration options: 'Network Interface' (WAN), 'Logical Type' (OR), 'Source IP', 'Source Port', 'Destination IP', and 'Destination Port', each with a corresponding text input field. The 'Protocol' section has four radio button options: TCP, UDP, ICMP, and ARP. A 'Start' button is located at the bottom right of the form.

Ping is used to examine whether a network works normally through sending test packets and calculating response time.

Instructions for using Ping:

1. Enter the IP address or domain name of a network, a website or a device in the input box of Ping, and then click **Ping**.
2. If related messages are received, it means the network works normally; otherwise, the network is not connected or is connected faultily.

Traceroute is used to determine a route from one IP address to another.

Instruction for using Traceroute:

1. Enter the IP address or domain name of a destination device in the input box of Traceroute, and then click **Traceroute**.
2. View the route information from the returned message.

Nslookup (Name Server Lookup) is a network command-line tool to obtain domain name of internet or to diagnose the problems of DNS.

Instruction for using Nslookup:

1. Enter a domain name and then click **Nslookup**.
2. View the DNS information from the returned message.

Network Capture

On the following interface, you can capture data packages of the available network ports. You can also set source IP, source port, destination IP or destination port to capture the packages that you want.

There is a "and"/" or "logical type. The "and" relationship can only capture a one-way message, or "or" relationship to fetch the interaction message between a particular IP.

Note: If there are multiple source or destination IP addresses, please use ‘|’ to separate them, for example, 172.16.115.12|172.16.115.15.

After package capturing is completed, save the captured packages on a computer and then use a tool to analyze them.

5.4.10 VPN

VPN (Virtual Private Network) is a network technology that creates a secure remote network connection over a public network through encrypted tunnel and conversion of data's destination address. UC120-1V1S1O can serve as a VPN client to connect with VPN server.

UC120-1V1S1O supports the following VPN protocols:

Layer 2 Tunneling Protocol (L2TP) is a protocol used to package data of PPP link layer and transmit the data between two sites over the Internet through a tunnel.

Point-To-Point Tunneling Protocol (PPTP) is another tunneling protocol used to connect a remote client to a private server over the Internet. PPTP is an enhanced security protocol

which supports VPN. And its security can be enhanced through PAP (Password Authentication Protocol) and EAP (Extensible Authentication Protocol).

OpenVPN is a kind of VPN based on the application layer of OpenSSL. It allows VPN clients to use a shared key, certificates or username/password to authenticate themselves.

UC120-1V1S10 works as a VPN client

Figure 5-46 UC120 Works as PPTP Client

Table 5-17 Explanation of Parameters for PPTP Client

Status	Whether to enable the PPTP client function (UC120-1V1S10 works as PPTP client)
Default Route	Whether to enable default route; If default route is enabled, data are transmitted between PPTP client and PPTP server through VPN route; if it is not enabled, data are transmitted between PPTP client and PPTP server through network's outbound route.
Data Encryption	Whether to encrypt data during data transmission
Server Address	The IP address of the PPTP server that assigns account to PPTP client
Username	The username of the account assigned by PPTP server to PPTP client
Password	The password of the account assigned by PPTP server to PPTP client

L2TP: UC120-1V1S10 works as a L2TP client and is connected to L2TP server.

Figure 5-47 UC120 Works as L2TP Client

The screenshot shows the configuration page for L2TP Client. The 'Status' and 'Default Route' are both set to 'Enable'. The 'Server Address' is '172.19.0.7', the 'Username' is 'admin', and the 'Password' is masked with dots. There are 'Cancel', 'Save', and 'Reset' buttons at the bottom.

Table 5-18 Explanation of Parameters for L2TP Client

Status	Whether to enable the L2TP client function (UC120-1V1S10 works as L2TP client)
Default Route	Whether to enable default route; If default route is enabled, data are transmitted between L2TP client and L2TP server through VPN route; if it is not enabled, data are transmitted between L2TP client and L2TP server through network's outbound route.
Data Encryption	Whether to encrypt data during data transmission
Server Address	The IP address of the L2TP server that assigns account to L2TP client
Username	The username of the account assigned by L2TP server to L2TP client
Password	The password of the account assigned by L2TP server to L2TP client

OpenVPN: Allow a single point of VPN to use certificate to authenticate itself.

Figure 5-48 UC120 works as a OpenVPN client

The screenshot displays the 'OpenVPN / OpenVPN' configuration page. At the top, there are three tabs: 'OpenVPN', 'L2TP', and 'PPTP'. Below these, the 'VPN / OpenVPN' section is visible, with sub-tabs for 'OpenVPN Client', 'OpenVPN Server', 'CA', 'Certification Revocation', and 'Log'. The 'OpenVPN Client' sub-tab is selected. The configuration fields are as follows:

Field	Value / Status
Config Mode	Import from File(.ovpn)
Status	Disable
Default Route	Enable
Accept Push Route	Enable
Proto	Disabled (Red X)
Device	Disabled (Red X)
Remote Server	Disabled (Red X)
Root Ca Certificate	Disabled (Red X)
Client Certificate	Disabled (Red X)
Client Key	Disabled (Red X)
Auth Username	admin
Auth Password	Masked (dots)
Certificate	Choose File No file chosen

At the bottom of the form, there are two buttons: 'Save' and 'Reset'.

UC120-1V1S1O works as a VPN Server

Figure 5-49 UC120 works as a OpenVPN Server

Network / VPN

OpenVPN | L2TP | PPTP

VPN / OpenVPN

OpenVPN Client | **OpenVPN Server** | CA | Certification Revocation | Log

Server Instance

Index	Server	Device Mode	Proto	Port	Isolation	Max Clients	CA	Status
CA not created								

User List

Index	User Name	Valid Period	Server	Status
Server Instance not created				

Figure 5-50 UC120 works as a L2TP Server

Network / VPN

OpenVPN | **L2TP** | PPTP

VPN / L2TP

L2TP Client | **L2TP Server**

Status:

Start Address:

End Address:

Index	Username	Description	Status
This section contains no values yet			

Figure 5-51 UC120 works as a PPTP Server

Network / VPN

OpenVPN L2TP **PPTP**

VPN / PPTP

PPTP Client **PPTP Server**

Status: Enable

Data Encryption: Enable

Gateway: 192.168.11.239

Start Address: 192.168.11.230

End Address: 192.168.11.238

Save

Index	Username	Description
This section contains no values yet		

New

5.4.11 Static Route

On the **Network** → **Static Route** interface, you can configure static routes for the network.

Figure 5-52 Create New Static Route

Network / Static Route / New

Index: 1

Name: Static Route-1

Target IP: 192.168.1.102

Netmask: 255.255.255.0

Gateway: 172.16.1.5

Interface: WAN

Status: Enable

Cancel Save Reset

Table 5-16 Explanation of Parameters for Static Route

Name	The name of the static route
------	------------------------------

Target IP	The destination IP address of the static route
Netmask	The netmask of the static route, default: 255.255.255.0
Gateway	The IP address of the outbound gateway of the static route
Interface	The outbound interface of the static route, namely WAN port or LAN port
Status	The static route is enabled or disabled

5.4.12 Hosts

On the **Network** → **Hosts** interface, you can add a host file. After enabling the hosts file, you can visit the corresponding host by inputting the alias or domain name of the host. The format of the hosts file is as follows: IP address host alias/domain name.

The hosts file contains the mapping relationship between IP address and host name/alias/domain name. And the mapping relationship allows quick and convenient access to the host.

Figure 5-53 Enable Hosts File

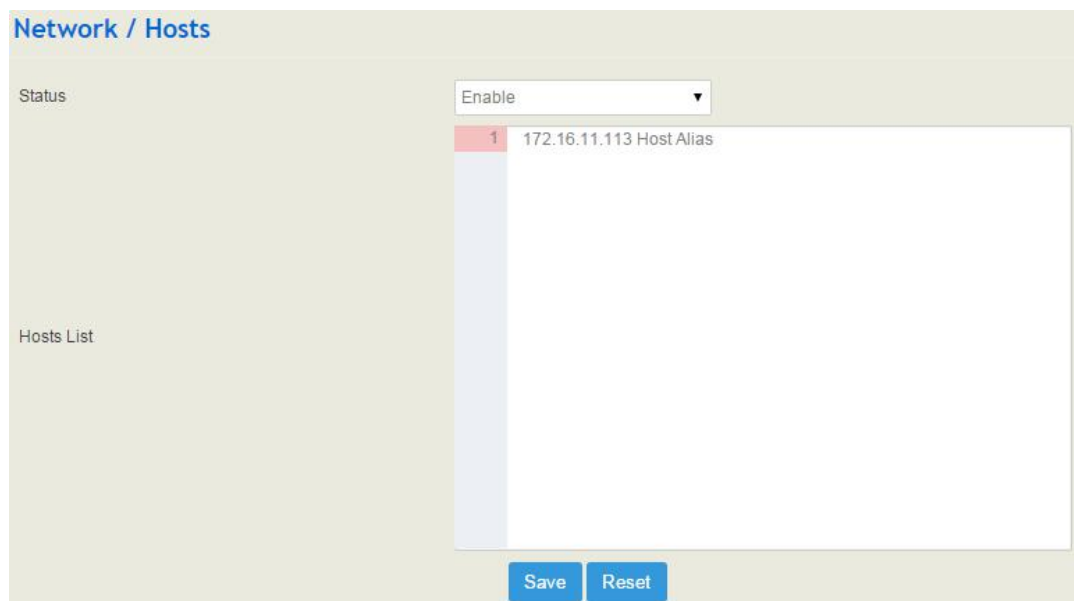

5.4.13 Fail2ban

Fail2ban is used to scan system logs and update firewall rules to reject the IP addresses that show malicious signs (for example, too many login failures) for a specified amount of time.

On the **Network** → **Fail2ban** interface, you can configure rules for Fail2ban. For UC120, Fail2ban is generally targeted SSH and SIP.

Figure 5-54 Configure Fail2ban Rules

Network / Fail2ban

SSH

Status

Ban Duration(second)

Max Retry Duration(second)

Max Retry

White List 

Black List 

SIP

Status

Ban Duration(second)

Max Retry Duration(second)

SIP Register Max Retry

SIP Invite Max Retry

White List 

Black List 

SSH/SIP	
Ban Duration (Second)	The time period during which the IP addresses that conform to the banning rule or are in the blacklist are prohibited. Range: 60-315360000 seconds
Max Retry Durations (second)	The time period during which the maximum retries have been executed and then the corresponding IP address will be banned. For example, if this parameter is set as 60 seconds and the maximum number of retries is set as 10, an IP address will be banned in case that it has tried 10 times during 60 seconds. Range: 5-3600
Max Retry	The maximum number of retries during a specific time. For example, if this parameter is set as 10 and the max retry duration is set as 60 seconds, an IP address will be banned in case that it has tried 10 times during 60 seconds. Range: 5-3600

White List	Those IP addresses that are in the white list will not be banned by Fail2ban.
Black List	Those IP addresses that are in the black list will not be banned by Fail2ban.

Note: If an IP address does not receive any response after it has sent out SSH/SIP attempts, and the network is reachable, you can go to the **Status → Fail2ban** interface to check whether the IP address is banned or not.

5.5 Profile

The Profile menu includes the following sub-menus: SIP, FXS/FXO, Codec, Number, Time, Manipulation and Dialplan.

5.5.1 SIP

On the **Profile → SIP** interface, you can set SIP information such as listening port, which will be used in extension and trunk. Multiple SIP profiles can be configured for one UC120-1V1S10 device, so you can choose different SIP profiles according to different needs.

Figure 5-55 Configure SIP Profile

The screenshot shows the 'Profile / SIP / New' configuration page. It contains the following fields and values:

- Index: 3
- Name: (empty)
- Local Listening Interface: WAN
- Local Listening Port: 5080
- NAT: Off
- Progress Timeout(s): 50
- DTMF Type: RFC2833
- RFC2833-PT: 101
- Process DTMF as Hold/Unhold: Off
- PRACK: Off
- Session Timer: Off
- Caller Number Source: From: User Part
- Called Number Source: To: User Part
- Inbound Codec Negotiation Priority: Remote

Inbound Codec Profile	1-< default >
Outbound Codec Profile	1-< default >
CNG(Comfort Noise Generator)	On
Bypass Media(SIP to SIP)	Off
Proxy Media(SIP to SIP)	Off
Detect Extension is Online	Off
Ignore ACK	Off
BLF	On
Allow Unknown Call	Off
Inbound Source Filter	0.0.0.0/0
QoS	Off
User Agent	Hostname / Full Firmware Ver
Encryption	Off
Timer T1(ms)	500
Timer T2(ms)	4000
Timer T4(ms)	4000
Timer T1X64(ms)	32000

Table 5-19 Explanation of Parameters for SIP Profile

Name	The name of the SIP profile
Local Listening Interface	The local listening interface of this SIP profile. It can be WAN port, LAN port, Open VPN, L2TP and PPTP. If the SIP profile is used by a SIP trunk, the interface filled in here is the listening port for the SIP trunk.
Local Listening Port	The local listening port of this SIP profile. If the SIP profile is used by a SIP trunk, the port filled in here is the listening port for the SIP trunk.
NAT	Starting NAT can speak on different networks, including four: uPNP/NAT-PMP、IP Address、Stun、DDNS
Progress Timeour(s)	If the parameter is set as 50 seconds, it means that the call will be considered as timeout in case that no one answers the



	call during 50 seconds.
DTMF Type	DTMF is short for Dual Tone Multi Frequency There are three DTMF modes, including SIP Info, INBAND, RFC2833
RFC2833-PT	RFC2833 payload coding
Process DTMF as Hold/Unhold	By default, this parameter is off. When it is set as on, DTMF will be addressed as call hold/unhold.
PRACK	Provisional Response ACKnowledgement
Session Timer	Session Expires: The validity period of a SIP session. When a SIP session times out, an invite message needs to be sent to refresh the session, otherwise, the session ends; It is 1800 seconds by default Min Session Expires: the minimum validity period to respond to a SIP session. Session Refresh Method: re-INVITE or UPDATE
Caller Number Source	From: User Part : to obtain the caller number from the user part contained in the 'From' field. From: Display Name: to obtain the caller number from the display name contained in the 'From' field. To: User Part: to obtain the caller number from the user part contained in the 'To' field. Contact: User Part: to obtain the caller number from the user part contained in the 'Contact' field.
Called Number Source	From: User Part : to obtain the called number from the user part contained in the 'From' field. From: Display Name: to obtain the called number from the display name contained in the 'From' field. To: User Part: to obtain the called number from the user part contained in the 'To' field. Contact: User Part: to obtain the called number from the user part contained in the 'Contact' field.
Inbound Codec Negotiation Priority	To take the remote device or the local device as priority for inbound codec negotiation Assume local device supports PCMA, PCMU, G.729 and G.723, while the remote device supports G.723 and G.729 If remote device is taken as codec negotiation priority, G.723 will be the codec mode, since the remote device supports



	G.723 and G.729 and G.723 is prior to G.729
Inbound Codec Profile	The codec supported by SIP for inbound calls
Outbound Codec Profile	The codec supported by SIP for outbound calls
Bypass Media(SIP to SIP)	Whether to allow SIP to communicate with the server directly
Detect Extension is Online	Whether to detect the SIP extension using this SIP profile is online or not
Allow Unknown Call	If this function is enabled, incoming calls from unknown sources are allowed. Unknown sources are those IP addresses that do not fall into the source range configured for SIP trunks or SIP extensions
Inbound Source Filter	The source of inbound calls, which is allowed. It can be an IP address or a network segment. If it is a network segment, the format is 172.16.0.0/16 or 172.16.0.0/255.255.0.0, which means calls from the network segment of 172.16 is allowed to come in. 0.0.0.0 means calls of any source is allowed to come in
QoS	Whether to enable QoS. QoS is a technology used to solve network delay or congestion
User Agent	Then content of the 'user agent' field in SIP packets
Encryption	Whether to encrypt this SIP profile
Timer T1	The value of timer T1 in SIP protocol. Default value is 500ms
Timer T2	The value of timer T2 in SIP protocol. Default value is 4000ms
TimerT4	The value of timer T4 in SIP protocol. Default value is 5000ms
Timer T1X64 (ms)	The value of timer T1X64 in SIP protocol. Default value is 32000ms

5.5.2 FXS/FXO

On the **Profile** → **FXS/FXO** interface, you can configure the driving parameters of FXS port and FXO port, including tone standard, dial timeout, ring timeout, hook-flash detection, DTMF parameters, CID-related parameters, impedance, dialplan and so on.

Figure 5-56 FXS/FXO Profile

Profile / FXS							
Index	Name	Tone Group	Digit Timeout(s)	Dial Timeout(s)	Ring Timeout(s)	No Answer Timeout(s)	
1	default	China	4	10	55	55	 
New							

Profile / FXO							
Index	Name	Tone Group	Digit Timeout(s)	Dial Timeout(s)	Ring Timeout(s)	No Answer Timeout(s)	
1	default	China	4	10	55	55	 
New							

Click  , and corresponding configuration interface will pop up.

Figure 5-57 Configure FXS Parameters

Profile / FXS / Edit

Index	1
Name	<input type="text" value="default"/>
Tone Group	<input type="text" value="China"/>
Digit Timeout(s)	<input type="text" value="4"/>
Dial Timeout(s)	<input type="text" value="10"/>
Ring Timeout(s)	<input type="text" value="55"/>
No Answer Timeout(s)	<input type="text" value="55"/>
Flash Detection	<input checked="" type="checkbox"/>
Min Time (ms)	<input type="text" value="100"/>
Max Time (ms)	<input type="text" value="400"/>
DTMF Parameters	
DTMF Send Interval(ms)	<input type="text" value="200"/>
DTMF Duration(ms)	<input type="text" value="200"/>
DTMF Gain	<input type="text" value="-6dB"/>
DTMF Detect Threshold	<input type="text" value="-30dB"/>
DTMF Terminator	<input type="text" value="#"/>
Send DTMF Terminator	<input type="text" value="Off"/>
CID Send Mode	<input type="text" value="FSK-BEL202"/>
Message Mode	<input type="text" value="MDMF"/>
Message Format	<input type="text" value="Display Name and CID"/>
CID Send Timing	<input type="text" value="Send After RING"/>
Delay Timeout After Ring(ms)	<input type="text" value="2000"/>
Impedance	<input type="text" value="600 Ohm"/>
REN(Ringer Equivalency Number)	<input type="text" value="1"/>
Send Polarity Reverse	<input type="text" value="On"/>
Send Flash Hook via SIP INFO / RFC2833	<input type="text" value="Off"/>
Offhook Current Detect Threshold	<input type="text" value="12mA"/>
Onhook Current Detect Threshold	<input type="text" value="10mA"/>
Dialplan	<input type="text" value="Off"/>

Table 5-20 Explanation of FXS Parameters

Name	The name of this FXS profile
Tone Group	The national standard of dialing tone, busy tone and ring tone; default value is China
Digit Timeout (s)	The timeout value for dialing a digit of a telephone number; When the time of dialing a digit exceeds this value, the system will think the dialing has completed; Default value is 4 seconds
Dial Timeout (s)	The timeout value for dialing the first telephone number after off-hook; Default value is 10 seconds
Ring Timeout (s)	The timeout value for the ringing of the analog phones of the FXS port when there are incoming calls
No Answer Timeout (s)	The timeout value for ending a call which goes out through the FXS port, when nobody answers the call.
Flash Detection	Whether to enable flash-hook detection; If flash detection is not enabled, the press on flash-hook will be ignored and won't be processed.
Min Time(ms)/ Max Time(ms)	Min Time: when flash-hook detection is enabled, if the time of the press on the flash-hook is less than this minimum time, the press will be ignored and won't be processed. Max Time: when flash-hook detection is enabled, if the time of the press on the flash-hook is longer than this maximum time, the phone will be hanged up.
DTMF Send Interval(ms)	The minimum interval between the sending of two DTMF tone DTMF: Dual Tone Multi Frequency
DTMF Gain	Signal gain of DTMF
DTMF Duration (ms)	The minimum duration of a DTMF tone
DTMF Detect Threshold	The threshold for the device to detect DTMF
DTMF Terminator	The terminator for ending DTMF detection. It means when the terminator is detected, the system will think the dialing is completed and begin to process call.
Send DTMF Terminator	Whether to send DTMF terminator
CID Send Mode	The modes of sending CID to the called phone when there are incoming calls, including FSK and DTMF; FSK: Frequency-shift keying; CID: Caller ID
Message Mode	The message modes to display caller information, including SDMF and MDMF

Message Format	The message formats to display caller information, including Display Name and CID, Only display Name, Only display CID
Send CID Before Ring	If it is enabled, the CID will be shown before ringing; otherwise, CID will be displayed after ringing
Send CID After Ring(ms)	If it is enabled, the CID will be shown after ringing; otherwise, CID will be displayed before ringing
Delay Timeout After Ring (ms)	The maximum interval between ringing and displaying of CID
Impedance	The impedance (SLIC) matched with analog phones
REN(Ringer Equivalency Number)	The equivalent number of ringing phones. It is used to determine how many devices can be connected by telephone lines. Range: 1 to 4
Polarity Reverse	If polarity reverse is on, call tolls will be calculated based on the changes in voltage. If polarity reverse is off, you need to set the time for offhook detect and call tolls will be calculated starting from the set time.
Send Flash Hook via SIP INFO	If this parameter is on, signal of flash-hook is sent via SIP INFO
Offhook Current Detect Threshold	This current threshold is used to determine whether a phone is offhook.
Onhook Current Detect Threshold	This current threshold is used to determine whether a phone is onhook.
Dialplan	The rules for dialing. The UC120-1G1S10 device supports regular expression. Please make reference to Profile → Dianplan section.

Figure 5-58 Configure FXO Parameters

Profile / FXO / Edit

Index	1
Name	<input type="text" value="default"/>
Tone Group	<input type="text" value="China"/>
Digit Timeout(s)	<input type="text" value="4"/>
Dial Timeout(s)	<input type="text" value="10"/>
Ring Timeout(s)	<input type="text" value="55"/>
No Answer Timeout(s)	<input type="text" value="55"/>
Detect Polarity Reverse	<input type="text" value="Off"/>
Delay Offhook(s)	<input type="text" value="3"/>
Detect Caller ID	<input type="text" value="Detect after ring"/>
DTMF Detect Timeout(ms)	<input type="text" value="5000"/>
Dial Delay(ms)	<input type="text" value="400"/>
DTMF Parameters	
DTMF Send Interval(ms)	<input type="text" value="200"/>
DTMF Duration(ms)	<input type="text" value="200"/>
DTMF Gain	<input type="text" value="-6dB"/>
DTMF Detect Threshold	<input type="text" value="-30db"/>
DTMF Terminator	<input type="text" value="#"/>
Send DTMF Terminator	<input type="text" value="Off"/>
BusyTone Detect Parameters	
Detect Tone counts	<input type="text" value="8"/>
Detect Tone Delta(ms)	<input type="text" value="50"/>
Intermittent Ratio	<input type="text" value="1:1"/>
Dialplan	<input type="text" value="Off"/>

Table 5-21 Explanation of FXO Parameters

Name	The name of this FXO profile
Tone Group	The national standard of dialing tone, busy tone and ring tone; default value is China
Digit Timeout (s)	The timeout value for dialing a digit of a telephone number; When the time of dialing a digit exceeds this value, the system will think the dialing has completed; Default value is 4 seconds
Dial Timeout (s)	The timeout value for dialing the first telephone number after off-hook; Default value is 10 seconds
Ring Timeout (s)	The timeout value for the ringing of the analog phones of the FXS port when there are incoming calls
No Answer Timeout (s)	The timeout value for ending a call which goes out through the FXS port, when nobody answers the call.
Detect Polarity Reverse	Whether to enable 'detect polarity reverse'. If 'detect polarity reverse' is on, call tolls will be calculated based on the changes in voltage. If 'detect polarity reverse' is off, you need to set the time for offhook delay and call tolls will be calculated starting from the set time.
Detect Caller ID	Detect before ring: the CID will be shown before ringing; otherwise, CID will be displayed after ringing; Detect after ring: the CID will be shown after ringing; otherwise, CID will be displayed before ringing Off: the CID will not be shown
DTMF Detect Timeout(s)	The timeout value to detect CID (in DTMF format)
Dial Delay(ms)	The delay time of dialing. Default value is 400ms
DTMF Send Interval(ms)	The minimum interval between the sending of two DTMF tone DTMF: Dual Tone Multi Frequency
DTMF Gain	Signal gain of DTMF
DTMF Duration (ms)	The minimum duration of a DTMF tone
DTMF Detect Threshold	The threshold for the device to detect DTMF
DTMF Terminator	The terminator for ending DTMF detection. It means when the terminator is detected, the system will think the dialing is completed and begin to process call.
Send DTMF Terminator	Whether to send DTMF terminator

Detect Tone counts	Set the number of busy notes to check
Detect Tone Delta	Set the error size to check the busy tone
Intermittent Ratio	The intermittent ratio to detect busy tone
Dialplan	The rules for dialing. The UC120-1G1S10 device supports regular expression. Please make reference to Profile → Dianplan section.

5.5.3 Codec

UC120-1V1S10 supports four codec modes, including G729, G723, PCMU and PCMA. You can adjust the priority of these four modes according to you needs.

Figure 5-59 Add or Delect Codec Profile

The screenshot shows the 'Profile / Codec / New' configuration page. It contains the following fields and controls:

- Index:** A dropdown menu with the value '2' selected.
- Name:** A text input field containing 'Codec1'.
- Audio Codec:** A dropdown menu with 'PCMA' selected, followed by a '20ms' dropdown menu with a green plus icon to its right.
- Video Codec:** A dropdown menu with 'VP8' selected, with red minus and green plus icons to its right.
- Buttons:** 'Cancel', 'Save', and 'Reset' buttons are located at the bottom of the form.



: Edit codec profile.



: Delete the corresponding codec profile or a codec mode.



: Create a new codec profile.

5.5.4 Number

On the **Profile → Number** interface, you can set a prefix for calling numbers or called numbers. When the prefix of a calling number or a called number matches the set prefix, the call will be passed to choose a route.

Figure 5-60 Number Profile

The screenshot shows the 'Profile / Number' configuration page with a table listing number profiles:

Index	Name	Caller Prefix	Caller Length	Called Prefix	Called Length	
1	Number 1	0755	*	*	*	

A 'New' button is located at the bottom right of the table area.



: Edit number profile.

 : Delete the corresponding number profile

Click , and you will see the following interface:

Figure 5-61 Create Number Profile



Profile / Number / New

Index: 1

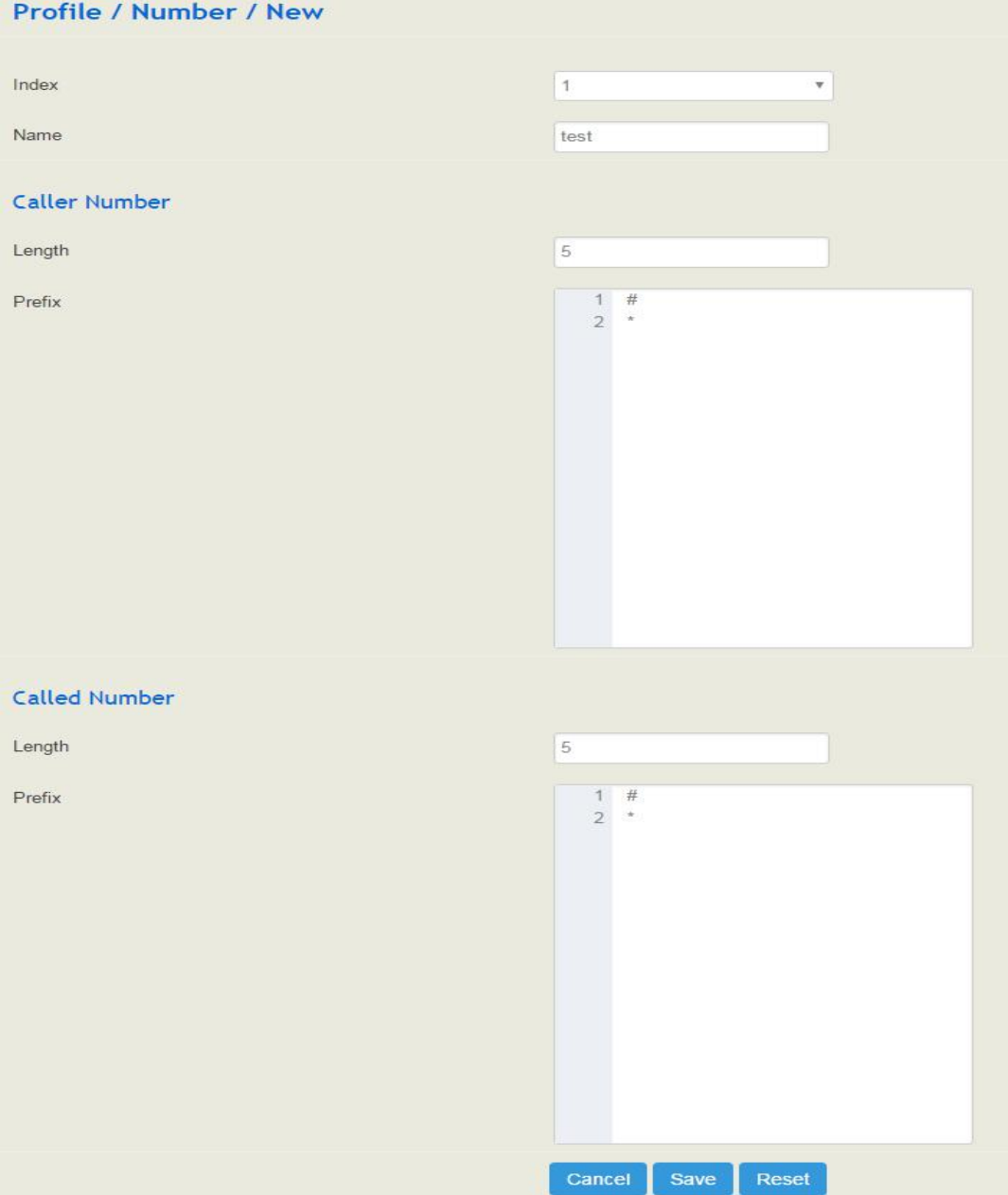
Name: test

Caller Number

Length: 5

Prefix: 1 #
2 *

Called Number

Length: 5

Prefix: 1 #
2 *

Cancel Save Reset

Table 5-22 Explanation of Number Parameters

Name	The name of the number profile
Prefix of Caller Number	The prefix of the calling number. It supports multiple prefixes, multiple rules for "or" relationships .It supports regular expression
Prefix of Called Number	The prefix of the called number. It supports regular expression. It Supports multiple prefixes, multiple rules for "or" relationships .

Length	The length of the calling number or called number. For example, : 4 6 7 means the calling number or called number must be 4 digits, 6 digits or 7 digits except the prefix
--------	--

Regex (Regular Expression) Syntax

Table 5-3 Explanation of frequently-used metacharacters in Regex

^	Matches the starting position in a number string. For example, ^134 matches the numbers starting with 134
\$	Matches the ending position of a string. For example, 2\$ matches the numbers ending with 2.
	Separates alternate possibilities. For example, 2 3 4 means 2,3or 4.
\	Marks the next character as a special character, a literal, a backreference, or an octal escape
[]	Matches a single character that is contained within the bracket. For example, [123] matches 1, 2, or 3. [0-9] matches any digit from "0" to "9".
[^]	Matches any one character except those enclosed in []. For example, [^9] matches any character except 9.
.	Matches any single character except the newline character. For example, 3.4 matches 314, 324, 334, 344.
?	Indicates there is zero or one of the preceding element. For example, colou?r matches both color and colour
*	Indicates there is zero or more of the preceding element. For example, ab*c matches ac, abc, abbc, abbbc, and so on.
+	Indicates there is one or more of the preceding element. For example, ab+c matches abc, abbc, abbbc, and so on, but not ac
\d	Mark any digit, equal to [0-9]
\D	Mark any character that is not a digit, equal to [^0-9]
\s	Mark any blank character such as a space or a tab.
\S	Mark any character that is not a blank character

Examples:

^0755	Matches the phone numbers with starting digits of 0755.
^0755 ^8899 ^0110	Matches the phone numbers with starting digits of 0755, 8899 or 0110.

<code>^[1][358][0-9]{9}\$</code>	Matches the phone numbers with the first digit as 1, the second digit as 3, 5 or 8, the left nine digits as any of 0 to 9.
----------------------------------	--

Note: the matching of number prefix also supports some digits that are not conform to the format of regular expression. For example, 0755 matches the numbers starting with 0755, and 0755|8899|0110 matches the numbers starting with 0755, 8899 or 0110.

5.5.5 SIM Number Learning

On the **Profile** → **SIM Number** interface, you can configure a number learning rule, which is used to send a text message (SMS) to a destination number and then the destination number will reply a message to the UC120 device. UC120 will match the key words of the reply message to detect the number of the SIM card.

Figure 5-62 SIM number learning rule

The screenshot shows a web interface for configuring a SIM Number Learning rule. The title is "Profile / SIM Number Learning / New". The form contains the following fields and values:

- Index: 1
- Name: Number Learning 1
- Type: SMS
- Destination Number: 10086
- Send Text: BJ
- Check SMS From Number: 10086
- Keywords: 号码为

At the bottom of the form, there is a "Matching Test" button and three buttons: "Cancel", "Save", and "Reset".

Index	The index of the SIM number learning rule, used to identify the rule
Name	The name of the SIM number learning rule, used to identify the rule
Type	UC120 only supports SMS currently.
Destination Number	The destination number that receives the text message. You can also enter a phone number to have a test.
Send Text	The text content that is sent to the destination number. It is based on the region where the SIM card belongs to.
Check SMS From Number	The UC120 device will not match the key words of the reply message unless this number is matched.
Keywords	The keywords used to detect the SIM number.

5.5.6 Time

On the **Profile** → **Time** interface, you can set a time period for calls to choose routes. If the local time when a call is initiated falls into the set time period, the call will be passed to choose the corresponding route.

Click the **New** button, and you will see the following interface:

Figure 5-63 CreateTime Profile

The screenshot shows a web interface for creating a new time profile. The breadcrumb is 'Profile / Time / New'. The form contains the following fields:

- Index:** A dropdown menu with the value '1' selected.
- Name:** A text input field containing 'Time 1'.
- Date Period:** A date range input field showing '2016-09-01~2016-09-30'. To the right of the field are two icons: a green plus sign (+) and a red minus sign (-).
- Weekday:** A row of checkboxes for the days of the week: Mon (checked), Tue, Wed, Thu, Fri, Sat, and Sun (all unchecked).
- Time Period:** A time range input field showing '00:00~23:59'. To the right of the field are two icons: a green plus sign (+) and a red minus sign (-).

At the bottom of the form, there are three buttons: 'Cancel', 'Save', and 'Reset'.

Table 5-23 Explanation of Time Parameters

Name	The name of the number profile
Date Period	Configure the starting date and ending date of a period : Add a date period : Delete a date period
Weekdate	Choose a weekdate
Time Period	Choose the starting time and ending time of a day

5.5.7 Manipulation

Number manipulation refers to the change of a called number or a caller number during calling process when the called number or the caller number matches the preset rules.

Click the **New** button, and you will see the following interface:

Figure 5-64 Create Manipulation Profile

The screenshot shows a web interface for creating a new manipulation profile. The title is "Profile / Manipulation / New". The form contains the following elements:

- Index:** A dropdown menu with the value "1".
- Name:** A text input field containing "Manipulation 1".
- Caller:** A checkbox that is checked.
- Delete Prefix Count:** An empty text input field.
- Delete Suffix Count:** An empty text input field.
- Add Prefix:** An empty text input field.
- Add Suffix:** An empty text input field.
- Replace by:** An empty text input field.
- Called:** An unchecked checkbox.

At the bottom of the form, there are three buttons: "Cancel", "Save", and "Reset".

Table 5-24 Explanation of Manipulation Parameters

Name	The name of this manipulation profile
Delete Prefix Count	The number of digits that are deleted from the left of the caller number or calling number
Delete Suffix Count	The number of digits that are deleted from the right of the caller number or calling number
Add Prefix	The prefix added to the caller number or the calling number
Add Suffix	The suffix added to the caller number or the calling number
Replace by	The number which replace the caller number or the calling number
	If the checkbox on the right of Caller is selected, it means the caller number will be manipulated; if the checkbox on the right of Called is selected, it means the called number will be manipulated.

Note: During number manipulation, deletion rules are carried out first, followed by adding rules. If 'Replace by' has been set, deletion rules and adding rules are invalid.

5.5.8 Speed Dial

On the **Profile** → **Speed Dial** interface, you can set one-digit or two-digit speed dial numbers for FXS/SIP calls. For example, if the short number (speed dial number) is set as 1, the long

number is set as 8000, and this speed dial profile is applied to an FXS/SIP extension, the FXS/SIP extension only needs to dial 1 and the call will be directed to the extension number of 8000.

Figure 5-65 Add Speed Dial Profile

Profile / Speed Dial / New

Index: 1

Name: Speedial1

Abbreviated Number Table

Name	Short Number	Long Number	Status
1	1	8000	Enable

Buttons: Cancel, Save, Reset

5.5.9 Dialplan

Dialplan is used for number dialing of calls through FXS and FXO ports. It supports Regular Expression (Regex) and DigitMap.

Figure 5-66 Add Dialplan

Profile / Dialplan / New

Index: 1

Name: Dailplan 1

Format: Regex

Dialplan: [Empty text area]

Buttons: Cancel, Save, Reset

Regex (Regular Expression) Syntax

^	Matches the starting position in a number string. For example, ^134 matches the numbers starting with 134
\$	Matches the ending position of a string. For example, 2\$ matches the

	numbers ending with 2.
	Separates alternate possibilities. For example, 2 3 4 means 2,3or 4.
\	Marks the next character as a special character, a literal, a backreference, or an octal escape
[]	Matches a single character that is contained within the bracket. For example, [123] matches 1, 2, or 3. [0-9] matches any digit from "0" to "9".
[^]	Matches any one character except those enclosed in []. For example, [^9] matches any character except 9.
.	Matches any single character except the newline character. For example, 3.4 matches 314, 324, 334, 344.
?	Indicates there is zero or one of the preceding element. For example, colou?r matches both color and colour
*	Indicates there is zero or more of the preceding element. For example, ab*c matches ac, abc, abbc, abbbc, and so on.
+	Indicates there is one or more of the preceding element. For example, ab+c matches abc, abbc, abbbc, and so on, but not ac
/d	Mark any digit, equal to [0-9]
/D	Mark any character that is not a digit, equal to [^0-9]
/s	Mark any blank character such as a space or a tab.
/S	Mark any character that is not a blank character

Examples of Regex Syntax:

^0755	Matches the phone numbers with starting digits of 0755.
^0755 ^8899 ^0110	Matches the phone numbers with starting digits of 0755, 8899 or 0110.
^[1][358][0-9]{9}\$	Matches the phone numbers with the first digit as 1, the second digit as 3, 5 or 8, the left nine digits as any of 0 to 9.

DigitMap Syntax:

Supported Objects	Digit	0-9
	T	Timer
	DTMF	A digit, a timer, or one of the symbols of A, B, C, D, #, or *
Range	[]	One or more DTMF symbols enclosed in the [], but only one DTMF symbol can be selected
Range	()	One or more expressions enclosed the (), but only one can be selected

Separator		Separate expressions or DTMF symbols.
Subrange	-	Two digits separated by hyphen (-) which matches any digit between and including the two digits.
Wildcard	x	Matches any digit of 0 to 9
Modifiers	.	Matches 0 or more times of the preceding element
Modifiers	?	Matches 0 or 1 times of the preceding element

Examples of DigitMap Syntax

(13 15 18)xxxxxxxx	Matches the phone numbers with starting digits as 13, 15 or 18 and the left nine digits as any of 0 to 9
[2-8]xxxxxx 13xxxxxxxx	Matches the phone numbers starting with any digit of 2 to 8 and the left six digits as any of 0 to 9; or matches the phone numbers starting with 13 and the left nine digits as any of 0 to 9

5.5.10 AutoCLIP

AutoCLIP is mainly used to SIP trunks, FXO trunks and VoLTE trunks and it helps record the outgoing and incoming calls of a trunk.

Figure 5-67 Configure AutoCLIP Rule

Index	The index of AutoCLIP profile
Name	The name of AutoCLIP profile

Record Strategy	You can choose missed calls or all calls. If missed calls is selected, uc120 will record the missed calls of the trunk. If all calls are selected, all the calls going through the trunk will be recorded
Record Expire (hour)	The validity period of a record. For example, if this parameter is set as 2 hours, the record will be valid in 2 hours since the record is generated. During the validity period, if there is coming call for the extension number contained in the record, the call will directly led to the extension without routing.
Delete Used Record	By default, this parameter is disabled. If this parameter is selected, those records that have been used to match extension number or trunk will be deleted.
Match Outgoing Trunk	By default, this parameter is enabled. If this parameter is enabled, those calls going through the trunks in the record can coming in without routing.

5.5.11 Recording

On the **Profile**→ **Recording** interface, you can choose SD card or Udisk as master/slave storage location.

How to Record Calls:

Configure a recording profile (or choose one of the two default recording profiles), and then add it to a SIP/FXS route. When there are calls going through the route and match the recording profile, the calls will be recorded.

Figure 5-68 Add recording profile

Profile / Recording

Configuration Recording List

Master Storage Location

Slave Storage Location

Index	Name	Strategy	Recording Direction	Stereo	Min Duration(s)	Silence Detect	
1	auto_record	Auto Recording After Answer	Inbound & Outbound	Off	1	Off/!-/!	<input type="checkbox"/> <input type="checkbox"/>
2	manual_record	Manual Recording After Answer	Inbound & Outbound	Off	1	Off/!-/!	<input type="checkbox"/> <input type="checkbox"/>

Figure 5-69 View Recording List

Profile / Recording

Configuration Recording List

Index:

Name:

Strategy:

Recording Direction:

Stereo:

Min Duration(s):

Silence Detect:

Initial Silence Timeout(s):

Final Silence Timeout(s):

Silence Detect Threshold:

Index	The index of the recording profile Range: 1-32
Name	The name of the recording profile, used to identify the recording profile
Strategy	Auto Recording after Answer: start recording after the callee pick up the phone. Ban Recording: either caller or callee enables his function, and then the call in both directions will not be recorded. Manual Recording after Answer: press *3 to start recording after the callee answers the call.
Recording Direction	Inbound & Outbound: If this recording profile is added to FXS/SIP extension, both inbound and outbound calls will be recorded. Inbound: If this recording profile is added to FXS/SIP extension, only inbound calls will be recorded. Outbound: If this recording profile is added to FXS/SIP extension, only outbound calls will be recorded. Note: If this recording profile is added to routing, this parameter is invalid and all calls going through the routing will be recorded.
Min Duration	If the actual recording time is shorter than this value, the recording file will not be saved.
Silence Detect	Select on or off.
Initial Silence Timeout(s)	若开始静音小于超时时间，后续有声音，则不会停止录音； 若开始静音大于超时时间，后续有声音，录音时长大约为设定的超时时间左右。

	<p>If the time of initial silence is shorter than this timeout value and there is voice afterwards, the recording will not stop.</p> <p>If the time of initial silence is longer than this timeout value, and there is voice afterwards, the recording will stop when the recording time reaches the preset value.</p>
Final Silence Timeout(s)	<p>If the time of final silence is shorter than this timeout value and there is voice afterwards, the recording will not stop.</p> <p>If the time of final silence is longer than this timeout value, and there is voice afterwards, the recording will stop before the call ends.</p> <p>Note: The uc120 will not execute final silence detection unless the initial silence is shorter than its timeout value.</p>
Silence Detect Threshold	The threshold for silence detection.

You can click **Recording List** to view the recording files which show the caller/called number, recording duration and so on. You can also play, download or delete the recording files on this interface.

5.5.12 Voice Mail

On the **Profile** → **Voice Mail** interface, you can configure the location, number and duration of a voice mail.

How to use voice mail:

Go to the **Extension** → **SIP** or **Extension** → **FXS** interface, enable the voice mail function, and then calls that times out will enter into voice mail.

Figure 5-70 Configure Voicemail Profile

Profile / Voicemail

Configuration Message List

Master Storage Location SD Card ▼

Slave Storage Location SD Card ▼

Max Messages Per User 50

Maximum of Login Attempts 3

Maximum of Operation Failure 3

Min Message Time(sec) 3 ▼

Max Message Time(min) 2 ▼

Auto Play New Message

Play CID Number

Play from Latest Message

Play Message Date Before Playing Message ▼

Cancel **Save** **Reset**

Master/Slave Storage Location	Select SD card or Udisk
Max Message Per User	If this maximum number of messages is reached, a prompt voice “the mail box is full” will be played.
Maximum of Login Attempts	If this maximum number of attempts (by dialing *170*2 to log in the voice mailbox) is reached, the call will hang up.
Maximum of Operation Failure	When a call enters into the voice mailbox and the caller dial inexistent DTMF repeatedly, the caller will be forced to log out the voice mailbox after the repetition times exceed this value.
Min Message Time (second)	The minimum duration of a voice mail
Max Message Time (second)	The maximum duration of a voice mail.
Auto Play New Message	If this parameter is on, new messages will be played automatically. If it is off, a prompt voice “please dial 1 to listen to new message” will be given.
Play CID Number	If this parameter is on, the caller number will be played together with messages.
Play from Latest Message	If this parameter is on, the latest messages will be played first.
Play Message Date	When to play message date. You can choose ‘Before Playing Message’, ‘After Playing Message’ and ‘Never’.

You can click **Message List** to view the voicemail files which show the caller/called number, message duration and so on. You can also play, download or delete the message files on this interface.

5.6 Extension

5.6.1 SIP

On the **Extension** → **SIP** interface, you can configure the SIP accounts registered in the UC120-1V1S10 by SIP clients (hereby UC120-1V1S10 is regarded as a SIP server).

Figure 5-71 Configure SIP Extension

Extension / SIP / Edit	
Index	1
Name	<input type="text" value="1000"/>
Extension	<input type="text" value="1000"/>
Password	<input type="password" value="...."/>
DID	<input type="text"/>
Register Source	<input type="text" value="Any"/>
Call Waiting	<input type="text" value="Off"/>
Do Not Disturb	<input type="text" value="Off"/>
Call Forward Unconditional	<input type="text" value="Off"/>
Call Forward Unregister	<input type="text" value="Off"/>
Call Forward Busy	<input type="text" value="Off"/>
Call Forward No Reply	<input type="text" value="Off"/>
NAT	<input type="text" value="Off"/>
Call In Filter	<input type="text" value="Black List"/>
Call In Black List	<input type="text" value=" < Add New ... >"/>
Call Out Filter	<input type="text" value="White List"/>
Call Out White List	<input type="text" value=" < Add New ... >"/>
SIP Profile	<input type="text" value="2-< wan_default >"/>
Status	<input type="text" value="Enable"/>

Table 5-25 Explanation of Parameters for SIP Extension

Name	The name of this SIP extension
Extension	The SIP account of the extension registered in UC120 by a SIP client
Password	The password of the SIP account registered in UC120 by a SIP client
DID	Direct Inward Dialing; if the called number is same with DID, the call will be directly forwarded to the extension, rather than choosing a route. Users can set multiple DID.
Register Source	If 'Any' is chosen, all SIP clients are allowed to register the SIP account of this extension; if 'Specified' is chosen, only the SIP client with the specified IP address or network segment is allowed to register the SIP account of this extension. For example, 172.16.0.0/16 means the register source is 172.16
Call Waiting	If a calling party places a call to a called party which is otherwise engaged, and the called party has the call waiting feature enabled, the calling party will hear an IVR voice.
Do Not Disturb	If 'Do Not Disturb' feature is enabled, calls cannot reach the called party.
Call Forward Unconditional	If 'Call Forward Unconditional' feature is enabled, all coming calls will be forwarded to a preset number.
Call Forward Unregister	When the SIP extension is not registered, you can transfer all the calls to the set number
Call Forward Busy	If 'Call Forward Busy' feature is enabled, new coming call will be forwarded when the corresponding local port is busy.
Call Forward No Reply	If 'Call Forward No Reply' feature is enabled, calls will be forwarded when nobody answer the calls during a specified period.
NAT	If NAT is enabled, the IP address of SIP extension in LAN will be turned into the outbound IP address of public network, thus making NAT traversal possible
Call In Filter	When you breathe in to SIP, you match the relevant filter conditions
Call Out Filter	When the SIP is called out, The filter conditions are matched
Call In Black List	The rules in the list will not take effect
Call Out White List	The rules in the list take effect
SIP Profile	The SIP profile that is selected for the extension
Status	If it is enabled, this SIP extension is registered to UC120-1G1S10; Otherwise the SIP extension is not registered

5.6.2 FXS

On the **Extension** → **FXS** interface, you can configure the parameters of the FXS extension.

Figure 5-72 Configure Parameters of FXS Extension

Extension / FXS / Edit

Extension	8000
DID	<input type="text"/>
Register to SIP Server	On
Master Server	SIP Trunk / 95.22
Slave Server	Not Config
Username	1000
Auth Username	1000
Password
Specify Transport Protocol on Register URL	Off
Expire Seconds	1800
Retry Seconds	60
Hot Line	Off
Call Waiting	Off
Do Not Disturb	Off
Call Forward Unconditional	Off
Call Forward Busy	Off
Call Forward No Reply	Off
Input Gain	0 dB
Output Gain	0 dB
Work Mode	Voice
Call In Filter	Black List
Call In Black List	< Add New ...>
Call Out Filter	White List
Call Out White List	< Add New ...>
FXS Profile	1-< default >
Status	Enable

Cancel Save Reset

Table 5-26 Explanation of Parameters for FXS Extension

Extension	The extension account of FXS port, which is used to register
-----------	--

DID	Direct Inward Dialing; if the called number is same with DID, the call will be directly forwarded to the extension, rather than choosing a route.
Register to SIP Server	If it is enabled, the FXS extension account will be registered to the SIP trunk that has been set. Default is off.
Master Server	The address and port of the master SIP server; it is generally the IP address of a SIP trunk. Please make reference to Trunk → SIP section
Slave Server	The address and port of the slave SIP server
Username	User name when the FXS port account is registered
Auth Username	The username of this FXS extension account, which is used during register authentication
Password	The password of this FXS extension account, which is used during register authentication
Specify Transport Protocol on Register URL	Whether to specify transport protocol on register URL.
Expire Seconds	The validity period after the FXO trunk is registered successfully. When the time expires, the FXO trunk will send register request to the server. Default value is 1800s
Retry Seconds	When the FXO trunk fails to be registered, the interval to send register request; Default value is 60s
Hot line	If hotline is enabled, calls will directly go to the hotline number
Number	Holine number
Delay	The delay time for a call to be send out after dialing is completed
Call Waiting	If a calling party places a call to a called party which is otherwise engaged, and the called party has the call waiting feature enabled, the calling party will hear an IVR voice.
Do Not Disturb	If 'Do Not Disturb' feature is enabled, calls cannot reach the called party.
Call Forward Unconditional	If 'Call Forward Unconditional' feature is enabled, all coming calls will be forwarded to a preset number.
Call Forward Busy	If 'Call Forward Busy' feature is enabled, new coming call will be forwarded when the corresponding local port is busy.
Call Forward No	If 'Call Forward No Reply' feature is enabled, calls will be forwarded

Reply	when nobody answer the calls during a specified period.
Input Gain	The receiving gain of the FXS port
Output Gain	The sending gain of the FXS port
Work Mode	The working mode of the FXS port, including Voice and POS
Call In Filter	When a call is given to the FXS port of UC120-1V1S1O, the call will not be connected to the FXO port if it is in the blacklist
Call Out Filter	When a call goes out from the FXS port of UC120-1V1S1O, the call cannot go out if it is in the blacklist
Call In Black List	Calls from the number profiles in the blacklist will be blocked
Call Out White List	Calls from the number profiles in the whitelist will be not blocked
FXS Profile	The FXS profile that is selected for this FXS extension
Status	If it is on, this FXS extension can be used, otherwise, the FXS extension is unavailable.

5.6.3 Ring Group

On the **Extension → Ring Group** interface, you can group FXS extension and SIP extension(s) together and set strategy for choosing the FXS extension and which SIP extension to ring under a ring group. The ring group function is widely used in call centers.



Figure 5-73 Configure Ring Group

The screenshot shows a web interface for configuring a new ring group. The title is "Extension / Ring Group / New". The form contains the following fields and controls:

- Index:** A dropdown menu with the value "1".
- Name:** A text input field containing "Ring Group1".
- Members Select:** Two dropdown menus. The first is "FXS Extension" and the second is "SIP Extension / SIP Extension". Both dropdowns have a red "X" icon to their right, indicating they are required or have errors.
- Strategy:** A dropdown menu with the value "Sequence(Ascending)".
- Ring Group Number:** A text input field containing "8000".
- DID:** A text input field containing "8000", which is highlighted in light blue.
- Ring Time(5s~60s):** A text input field containing "25".

At the bottom of the form, there are three buttons: "Cancel", "Save", and "Reset".

Table 5-27 Explanation of Parameters for Ring Group

Name	The name of this ring group
Members Select	Select the FXS extension and an SIP extension or several SIP extensions;  : Add an extension to the ring group  : Delete an extension from the ring group
Strategy	The strategies for choosing which SIP extension to ring, including Sequence (Ascending), Sequence (Cyclic Ascending), Simultaneous and Random
Ring Group Number	The number of the ring group; it is generally the same with DID.
DID	Same with Ring Group Number; it is optional to fill in
Ring Time (5-60s)	The duration of ring when there is a coming call. Range: 5s to 60s

Note: If ring group function has been set, the call forwarding function is unavailable.

5.6.4 Paging Group

On the **Extension → Paging Group** interface, you can group SIP extensions into a paging group and then if there calls given from FXS/FXO/SIP to the paging group, the calls will be led to one extension of the paging group according to the preset strategy.

Figure 5-74 Configure Paging Group

Extension / Paging Group / New



Index

Name

Paging Group Number

Strategy

Members Select

Name	The name of this paging group
Paging Group Number	The number of the paging group. When there calls given from FXS/FXO/SIP to this number, the calls will be led to one extension of the paging group according to the preset strategy.
Strategy	Include one-way paging and two-way intercom. one-way paging: members of the paging group only can listen to the voice of presenter and cannot answer the call. two-way intercom: members of the paging group can have conversation with the presenter, but members cannot talk to each other.
Members Select	Select the SIP extensions that are added into the paging group. An SIP extension cannot exist in two paging groups at the same time. Click  to add an SIP extension to the paging group; Click  to delete an SIP extension from the paging group.

5.7 Trunk

5.7.1 SIP

SIP trunk can realize the connection between UC120-1V1S1O and IPPBX or SIP servers.

Figure 5-75 Configure SIP Trunk

Trunk / SIP / Edit

Index	1
Name	<input type="text" value="Telecom1"/>
Address	<input type="text" value="172.16.111.65"/>
Port	<input type="text" value="5080"/>
Outbound Proxy	<input type="text"/>
Port	<input type="text"/>
Transport	<input type="text" value="UDP"/>
Register	<input type="text" value="Off"/>
Heartbeat	<input type="text" value="Off"/>
SIP Profile	<input type="text" value="2-< wan_default >"/>
Status	<input type="text" value="Enable"/>

Table 5-28 Explanation of Parameters for SIP Trunk

Name	The name of the SIP trunk
Address	The IP address or domain name of the peer SIP devices or servers
Port	The SIP listening port of the peer SIP devices or servers; 5060 is the default port
Outbound Proxy	If outbound proxy is used, enter the IP address or domain name of the proxy server
Port	If outbound proxy is used, enter the listening port of the proxy server
Transport	Transport protocol: TCP or UDP
Register	If it is on, the SIP trunk will send register request to the peer device
Username	The username of this SIP trunk, it is generally a phone number
Auth Username	The username used for register authentication by this SIP trunk
Password	The password used for register authentication by this SIP trunk
From Header	Choose the registered username or the true caller ID for the 'from

Username	header' of the invite message when a call goes out.
Expire Seconds	The validity period after the SIP trunk is registered successfully. When the time expires, the SIP trunk will send register request to the server. Default value is 1800s
Retry Seconds	When the SIP trunk fails to be registered, the interval to send register request; Default value is 60s
Heartbeat	If heartbeat in on, heartbeat (options) messages will be sent to examine the connection with servers; The default value is 'Off'
Heartbeat Period	The interval of sending heartbeat (options) messages
SIP Profile	he SIP profile of the SIP Trunk; make reference to Profile → SIP section
Status	If it is enabled, it means the SIP Trunk can be used; otherwise, the SIP trunk is unavailable

Note:

If UC120-1V1S10 is regarded as a terminal and intends to register to a server, you need to configure a SIP trunk connecting UC120-1V1S10 and the server, and then enable register for the SIP trunk.

If the FXS f UC120-1V1S10 intends to register to a server, you need to configure a SIP trunk connecting UC120-1V1S10 and the server, then enable register for the port and designate the SIP trunk to it.

5.7.2 FXO

FXO Trunk interconnects the PSTN with UC120-1V1S10. Calls from the PSTN can come into the gateway and calls can go out from the gateway to search telephone numbers under the PSTN.

Different from the FXO ports of other gateways, the FXO port of UC120-1V1S10 only allows one-time dialing, which means called numbers needs to be dialed directly for calls that go out from the FXO port.

Figure 5-76 Configure FXO Trunk

Trunk / FXO

[FXO](#) [Automatch Impedance](#)

Trunk / FXO / Edit

Port	1
Extension	<input type="text" value="8001"/>
Autodial Number	<input type="text"/>
Register to SIP Server	<input type="text" value="On"/>
Master Server	<input type="text" value="SIP Trunk / 95.22"/>
Slave Server	<input type="text" value="Not Config"/>
Username	<input type="text" value="1000"/>
Auth Username	<input type="text" value="1000"/>
Password	<input type="password" value="...."/> 
From Header Username	<input type="text" value="Username"/>
Specify Transport Protocol on Register URL	<input type="text" value="Off"/>
Expire Seconds	<input type="text" value="1800"/>
Retry Seconds	<input type="text" value="60"/>
Display Name / Username Format	<input type="text" value="Caller ID / Caller ID"/>
Display Name / Username Format when CID unavailable	<input type="text" value="Display Name / Extension"/>
Input Gain	<input type="text" value="0dB"/>
Output Gain	<input type="text" value="0dB"/>
Impedance	<input type="text" value="600 Ohm"/>
FXO Profile	<input type="text" value="1-< default >"/>
Status	<input type="text" value="Enable"/>

Table 5-29 Explanation of Parameters for FXO Trunk

Port	The FXO port number
Extension	The extension account of the FXO port, which is used to register
Autodial Number	The autodial number of the FXO port when there are incoming calls
Register to SIP Server	If it is enabled, the FXO trunk will be registered to the SIP trunk that has been set. Default is off.
Master Server	The address and port of the master SIP server; it is generally the IP address of a SIP trunk. Please make reference to Trunk → SIP section
Slave Server	The address and port of the slave SIP server
Username	Username of the FXO port account, used for the authentication of registration
Auth Username	The username of this FXO trunk, which is used during register authentication
Password	The password of this FXO trunk, which is used during register authentication
From Header Username	Choose the registered username or the true caller ID for the 'from header' of the invite message when a call goes out.
Specify Transport Protocol on Register URL	Whether to specify transport protocol on register URL.
Expire Seconds	The validity period after the FXO trunk is registered successfully. When the time expires, the FXO trunk will send register request to the server. Default value is 1800s
Retry Seconds	When the FXO trunk fails to be registered, the interval to send register request; Default value is 60s
Display Name/Username Format	The format to display caller information, including: Caller ID/Caller ID Display Name/ Caller ID Extension/ Caller ID Caller ID/ Extension Anonymous
Display Name / Username Format when CID unavailable	Set the caller's caller id format when the main number is not detected
Input Gain	The receiving gain of the FXO port
Output Gain	The sending gain of the FXO port

Impedance	The impedance (SLIC) matched with phones
FXO Profile	The FXS profile that is selected for this FXS extension
Status	If it is on, this FXO trunk can be used, otherwise, the FXO trunk is unavailable.

FXO Automatch Impedance:

Click the **Detection** button, and the UC120-1V1S1O gateway will automatically detect the most-matched impedance.

Figure 5-77 FXO Automatch Impedance

The screenshot shows the 'Trunk / FXO' configuration interface. The 'Automatch Impedance' tab is active. The 'Current Impedance' field is set to '600 Ohm'. The 'DTMF' field contains the number '1234567890123456789'. The 'Automatch Optimum Impedance' field is empty. A 'Detect' button is located to the right of the DTMF field. At the bottom right, there are 'Cancel' and 'Save' buttons.

5.7.3 VoLTE Trunk

VoLTE trunk helps interconnect the LTE network with the IP network. The VoLTE function allows calls or SMS from the IP network to be transmitted to mobile network, and packs voice or SMS from mobile network into IP packages and send them to IP network.

Figure 5-78 Configure VoLTE Trunk

Trunk / VoLTE / Edit

Extension	<input type="text" value="8002"/>
Autodial Number	<input type="text"/>
Register to SIP Server	<input type="text" value="Off"/>
Display Name / Username Format	<input type="text" value="Caller ID / Caller ID"/>
Display Name / Username Format when CID unavailable	<input type="text" value="Extension / Extension"/>
Carrier	<input type="text" value="Auto"/> <input type="button" value="Refresh"/>
Check Carrier After Replacing Card	<input type="text" value="Off"/>
Reactive when register fail	<input type="text" value="On"/>
SMS Encoding	<input type="text" value="ucs2"/>
SMS Center Number	<input type="text"/>
CLIR	<input type="text" value="Auto"/>
PIN Code	<input type="text"/>
DSP Input Gain	<input type="text" value="0dB"/>
DSP Output Gain	<input type="text" value="0dB"/>
Module Speaker Gain	<input type="text" value="+7dB"/>
Module MIC Gain	<input type="text" value="+1dB"/>

SIM Number Learning Profile	<input type="text" value="Off"/>
Status	<input type="text" value="Enable"/>

Extension	The extension account of the VoLTE trunk, which is used to register
Autodial Number	The autodial number of the The address and port of the master SIP server; it is generally the IP address of a SIP trunk. Please make reference to Trunk → SIP section when there are incoming calls
Register to SIP Server	If it is enabled, the GSM trunk will be registered to the SIP trunk that has been set. Default is off.

Master Server	The master SIP server to which the VoLTE trunk is registered. Enter the address and port of the master SIP server; it is generally the IP address of a SIP trunk. Please make reference to Trunk → SIP section
Slave Server	The slave SIP server to which the VoLTE trunk is registered. Enter the address and port of the slave SIP server
Username	The username of this VoLTE trunk used for registration; it is generally a phone number
Auth Username	The username of this VoLTE trunk, which is used during register authentication
Password	The password of this VoLTE trunk, which is used during register authentication
From Header Username	Choose the registered username or the true caller ID for the 'from header' of the invite message when a call goes out.
Specify Transport Protocol on Register URL	Whether to specify transport protocol on register URL.
Expire Seconds	The validity period after the VoLTE trunk is registered successfully. When the time expires, the GSM trunk will send register request to the server. Default value is 1800s
Retry Seconds	When the VoLTE trunk fails to be registered, the interval to send register request; Default value is 60s
Display Name/Username Format	The format to display caller information, including: Caller ID/Caller ID Display Name/ Caller ID Extension/ Caller ID Caller ID/ Extension Anonymous
Display Name/Username Format when CID unavailable	The format to display caller information when CID is unavailable
Carrier	Click the Refresh button, and the gateway will automatically to identify the carrier of the inserted SIM card.
Reactive when register fail	Whether to reactivate the VoLTE trunk when register fails
SMS Encoding	ucs2 or 7bit, 7-bit is used to send original ASCII, while UCS2 is used to send various languages
SMS Center Number	Generally, the GSM module can automatically detect the SMS center number. This parameter will be used when the LTE

	module cannot detect the SMS center number.
CLIR	Whether to enable Calling Line Identification Restriction
PIN Code	PIN code is personal identification code. When SIM card is locked, you can modify the PIN code to prevent the SIM infor from being stolen
DSP Input Gain	Volume control of DSP input
DSP Output Gain	Volume control of DSP output
Module Speaker Gain	Volume control of module speaker
SIM Number Learning Profile	Choose a number learning profile for the SIM card. The SIM number will be displayed on the Status →PSTN→VOLTE page
Status	If it is on, this VoLTE trunk can be used, otherwise, the VoLTE trunk is unavailable

5.8 Call Control

This section is to configure routes or route groups for incoming and outgoing calls through UC120-1V1S1O, as well as IVR, SMS, USSD and so on.

5.8.1 Setting

Figure 5-79 Basic Setting of Call Control

Call Control / Setting

Voice

Disconnect call when no RTP packet	<input type="checkbox"/>
Packet Loss Concealment(PLC)	<input type="checkbox"/>
Echo Canceller Tail Length(ms)	64
Echo Gain	-4dB
DTMF Min Detect Interval(ms)	0
RTP Start Port	16000
RTP End Port	16200

Route

Local extension call	<input checked="" type="checkbox"/>
----------------------	-------------------------------------

FAX

Send Mode	T.30
Tone Detection by Local	<input type="checkbox"/>
SDP Param	
a=X-fax	<input type="checkbox"/>
a=fax	<input type="checkbox"/>
a=X-modem	<input type="checkbox"/>
a=modem	<input type="checkbox"/>

Table 5-30 Explanation of Parameters for Call Control

Disconnect call when no RTP packet	If it is enabled, and no RTP packets are received within the preset time, calls will be disconnected
Packet Loss Concealment (PLC)	Whether to enable the 'Packet Loss Concealment' function
Echo Canceller Tail Length (ms)	Default value: 64ms
DTMF Min Detect Interval (ms)	The minimum time for DTMF detection
Echo Gain	Default value: -4dB
RTP Start Port	The start port of RTP packets
RTP End Port	The end port of RTP packets
Local extension call	If it is enabled, calls between local extensions do not need routes.
Fax Mode	T38 or T30 (Pass-through)
Tone Detection by Local	If it is enabled, UC120-1V1S10 will detect fax tones automatically during a call and the call will be switched into fax mode after a fax tone is detected.
SDP Param 'a=X-fax'	Attribute parameter 'a=X-fax' is carried in SDP
SDP Param 'a=fax'	Attribute parameter 'a=fax' is carried in SDP
SDP Param 'a=X-modem'	Attribute parameter 'a=X-modem' is carried in SDP

5.8.2 Route Group

On the **Call Control →Route Group** interface, you can group SIP trunks, SIP extensions, FXS extension and FXO trunk together according to your needs and set strategy for choosing which trunk or extension as the destination route under a route group.

Figure 5-80 Create Route Group

The screenshot shows a web interface for creating a new route group. The title is 'Call Control / Route Group / New'. The form contains the following fields:

- Index:** A dropdown menu with the value '1' selected.
- Name:** A text input field containing 'Route Group 1'.
- Members Select:** A list of four items, each with a dropdown arrow and a small icon to its right:
 - SIP Trunk / Telecom1 (with a red 'x' icon)
 - FXS Extension (with a red 'x' icon)
 - SIP Extension / SIP Extensio (with a red 'x' icon)
 - FXO Trunk (with a red 'x' icon and a green '+' icon)
- Strategy:** A dropdown menu with 'Sequence(Ascending)' selected.

At the bottom of the form, there are three buttons: 'Cancel', 'Save', and 'Reset'.

Table 5-31 Explanation of Parameters for Route Group

Name	The name of the route group
Members Select	Select FXS extension, SIP extension, SIP trunk, FXO trunk or GSM trunk
Strategy	The strategies for choosing which route under the route group as the destination route, including Sequence (Ascending), Sequence (Cyclic Ascending), Simultaneous and Random

5.8.3 Route

On the **Call Control** → **Route** interface, you can configure routes for incoming calls and outgoing calls.

Figure 5-81 Create a Route

Call Control / Route / New

Priority

Name

Condition

Source

Number Profile

Caller Number Prefix

Called Number Prefix

Time Profile

Action

Manipulation

Destination

Failover Action

Table 5-32 Explanation of Route Parameters

Priority	The priority for choosing the route; the higher value, the lower priority
Name	The name of the route
Condition	The condition under which the route will be used
Source	The source of the call; it can be the FXS extension, SIP extension, FXO trunk ,GSM trunk, a customized source or any
Number Profile	The profile of the caller number and the called number; please make reference to the Profile → Number section.The default value is 'Off' Note: it cannot be simultaneously used with the following parameters of 'caller number prefix' and 'called number prefix'
Caller Number Prefix	The prefix of caller number; it supports regular expression

Called Number Prefix	The prefix of called number; it supports regular expression
Time Profile	The profile of time during which the route can be used; make reference to the Profile → Time section
Action	Include manipulating number and sending call to destination
Manipulation	If it is on, the caller number or called number of the route will be manipulated; make reference to the Profile → Manipulation section
Destination	The destination of the route
Failover Action	The processing when a call through this route fails

5.8.4 Feature Code















































UC120-1V1S10 provides convenient telephone functions. Connect a telephone to the FXS port and dial a specific feature code, and you can query corresponding information.

The following is the corresponding function of each feature code:

Figure 5-82 Feature Code

Call Control / Feature Code

Feature Code Service:

Index	Feature	Key	Description	Status
1	Inquiry LAN IP	*158	Inquiry LAN IP	Enabled  
2	Inquiry WAN IP	*159	Inquiry WAN IP	Enabled  
3	Inquiry Phone Number	*114	Inquiry Phone Number	Enabled  
4	Network Work Mode	*157*	Dial *157*0 to set route mode. Dial *157*1 to set bridge mode	Enabled  
5	IP Address Config Mode	*150*	*150*1#-Static, *150*2#-DHCP	Enabled  
6	Configure IP Address	*152*	Set IPv4 Address 192.168.1.10 by dial *152*192*168*1*10#	Enabled  
7	Configure Gateway	*156*	Set IPv4 Gateway 192.168.1.1 by dial *156*192*168*1*1#	Enabled  
8	Configure Subnet Mask	*153*	Set IPv4 Netmask 255.255.0.0 by dial *153*255*255*0*0#	Enabled  
9	Restart Device	*111	Restart Device	Enabled  
10	Call Waiting Activate	*51	Enable Call Waiting service	Enabled  
11	Call Waiting Deactivate	*50	Disable Call Waiting service	Enabled  
12	Blind Transfer	*1	Example: *18000#, you can blind transfer to the extension number ...	Enabled  
13	Attended Transfer	*2	Example: *28000#, you can attended transfer to the extension num...	Enabled  
14	Call Forwarding Uncondition Activate	*72*	Enable Call Forwarding Uncondition service. Example: *72*8000, set...	Enabled  
15	Call Forwarding Uncondition Deactivate	*73	Disable Call Forwarding Uncondition service	Enabled  
16	Call Forwarding Busy Activate	*90*	Enable Call Forwarding Busy service. Example: *90*8000, set the c...	Enabled  
17	Call Forwarding Busy Deactivate	*91	Disable Call Forwarding Busy service	Enabled  
18	Call Forwarding No Reply Activate	*92*	Enable Call Forwarding No Reply service. Example: *92*8000, set th...	Enabled  
19	Call Forwarding No Reply Deactivate	*93	Disable Call Forwarding No Reply service	Enabled  
20	DND Activate	*78	Enable Do Not Disturb service	Enabled  
21	DND Deactivate	*79	Disable Do Not Disturb service	Enabled  
22	Group Pickup	**	Pick up the ringing extension which in the same ringgroup, Examp...	Enabled  
23	WAN Access Control	*160*	*160*1# - Allow HTTP WAN access, *160*0# - Deny HTTP WAN a...	Enabled  

Note: All feature codes are enabled by default.

5.8.5 IVR

On the **Call Control → IVR** interface, you can carry out specific configurations for the IVR which has been uploaded from the **System → Voice** interface.

Figure 5-83 IVR Setting

Table 5-33 Explanation of IVR Parameters

Status	If it is disabled, the IVR cannot be seen in the destination of route.
Timeout	If it is set as '10', it means if no DTMF tone is received during 10 seconds, the IVR will be played repeatedly or the call will be hanged up. The default value is 10 seconds.
Enable Direct Extension	Whether to allow direct dialing of extensions during the playing of IVR
Repeat Loops	If it is set as '3', the call will be hanged up after the IVR has been repeated for three times during timeout.
Menu	DTMF: It can be 0-9 quick-dial numbers, *, #, others or timeout. Destination: the destination of the IVR; it can be an extension or a trunk. For example, if DTMF is configured as 1,2,3 and others, and the telephone key that is pressed is not 1, 2 or 3, the IVR will choose the destination of 'others'. When the the playing of the IVR times out, and user does not press any telephone key, the IVR will choose the destination of 'timeout'. When the destination is a trunk, user does not need to pre-configure the

	called number, and the system will prompt the user to dial the called number.
--	---

5.8.6 SMS Route

UC120-1V1S10 allows SMS to be sent between SIP clients, and meanwhile allow SMS to be sent between IP network/GSM network and GSM network. On the **Call Control** → **SMS Route** interface, you can establish route for these SMS.

For example, you can download a softphone on a PC which is connected to UC120-1V1S10, and type the content of the SMS through the softphone. Then configure a SMS route on the **Call Call Control** → **SMS Route** interface. The source of the SMS route is the number of the softphone.

Figure 5-84 Create SMS Route

Call Control / SMS Route / New

Priority

Name

From

Source

Src Number Prefix

Content Has the Words

To

Action

Destination

Dest Number Src

Dest Number

Add Prefix in Content

Add Suffix in Content

Table 5-34 Explanation of SMS Route Parameters

Priority	The priority for the SMS route; the higher value, the lower priority
Name	The name of the SMS route
Source	The source of the SMS route. It can be a trunk or an extension. It also can be a LTE SMS and USSD.
Src Number Prefix	Prefix the source number to support regular expressions
Content Has the Words	Match key words in text message content
Action	The text message action can choose whether to forward or reply
Destination	The destination of the SMS route. It can be a trunk or an extension.
Dest Number Src	The source of the destination number. There are two sources: custom and get from content.
Add Prefix in Content	The prefix of the SMS content. It is generally 'none', which means there is no prefix to be matched.
Add Suffix in Content	The suffix of the SMS content. It is generally 'none', which means there is no suffix to be matched.

5.8.7 SMS

If an SIM card has been inserted into the SIM slot, you can send or receive SMS on the **SMS** interface. The length of a SMS can not be more than 170 characters.

Figure 5-85 Send and Receive SMS

Notice

If the SIM fails, you will get a notice:SIM1: The module is not recognized successfully. Please check whether the module is supported or installed !

Send Message

Enter contents into the box on the left, and then input the number of recipient . Click **Send** in the last.

Note: If there are mutiple recipients , use | to separate them, for example, 13151103146|18954405566.

Receive Message

All SMS received by UC120 are displayed on the Receive List.

Read Message

Click  on the Receive List to read SMS contents.

Reply Message

Click , and then enter SMS contents in the box on the left. Click Send in the last.

Delete Message

Click  to delete an SMS.

Note: Group sending of SMS is not allowed.

5.8.8 USSD

USSD (Unstructured Supplementary Service Data) is a global system service for mobile (GSM) communication technology that is used to send text between a mobile phone and an application program in the network.

USSD is similar to Short Messaging Service (SMS), but, unlike SMS, USSD transactions occur during the session only. With SMS, messages can be sent to a mobile phone and stored for several days if the phone is not activated or within range.

Figure 5-86 USSD

Table 5-35 Explanation of USSD Parameters

USSD Code	USSD code is a special number starting with * or #, followed by 2~3 digits, then ending with #; Service provider feedbacks a service menu to user according to this USSD code.
Encode	Supports auto, 7-bit and UCS2; 7-bit is used to send original ASCII, while UCS2 is used to send any languages
USSD Message	The Content of the USSD message

5.8.9 Diagnostics

In case that call cannot be connected or voice has quality problem, you can enter into the **Call Control →Diagnostics** interface to collect fault-related information and then send it to technical support to locate fault.

Operation Procedures:

1. Select the module that needd to be traced. For example, if a call from SIP to FXS has voice problem, you can select SIP message, FXS/FXO and Voice, and then click the **Start** button.
2. Give a call, and come back to the **Call Control →Diagnostics** interface after the call ends. Then click Stop and download the tracing file.
3. In order to locate faluts more quickly, you sometimes need to enter into the **System →Service Log** interface, click export, and then send this exported file and the tracing file to technical support,

Figure 5-87 Call Tracing for Diagnostics

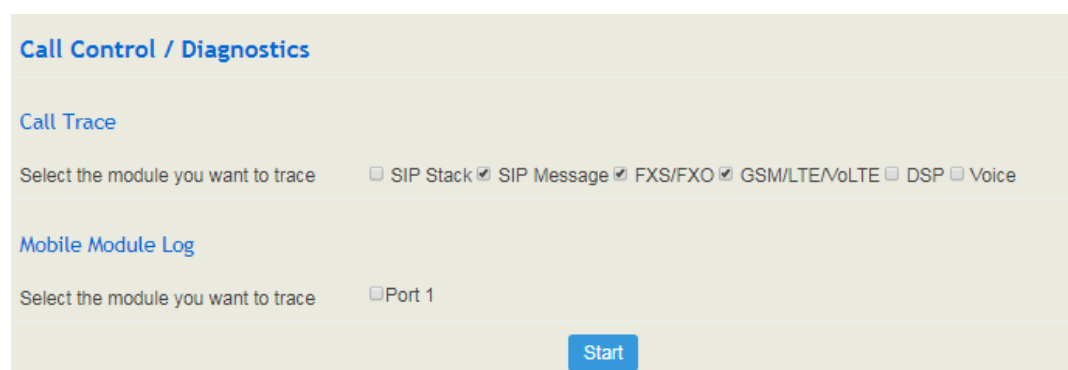

The screenshot displays the 'Call Control / Diagnostics' web interface. It features two main sections for selecting modules to trace. The first section, 'Call Trace', includes a label 'Select the module you want to trace' followed by a row of checkboxes: 'SIP Stack' (unchecked), 'SIP Message' (checked), 'FXS/FXO' (checked), 'GSM/LTE/VoLTE' (checked), 'DSP' (unchecked), and 'Voice' (unchecked). The second section, 'Mobile Module Log', includes a label 'Select the module you want to trace' followed by a single checkbox 'Port 1' (unchecked). A blue 'Start' button is positioned at the bottom right of the interface.

6 Glossary

Glossary	Description
ARP	Address Resolution Protocol
CID	Caller Identity
DNS	Domain Name System
DDNS	Dynamic Domain Name Service
DHCP	Dynamic Host Configuration Protocol
DMZ	Demilitarized Zone
DND	Do NOT Disturb
DTMF	DTMF: Dual Tone Multi Frequency
FTP	File Transfer Protocol
HTTP	Hypertext Transfer Protocol
LAN	Local Area Network
L2TP	Layer 2 Tunneling Protocol
PPTP	Point-to-Point Tunneling Protocol
MAC Address	Media Access Control Address
NAT	Network Address Translation
Ping	Packet Internet Grope
SIP	Session Initiation Protocol
TCP	Transmission Control Protocol
UDP	User Datagram Protocol
RTP	Real Time Protocol
PPPOE	Point-to-point Protocol over Ethernet
QoS	Quality of Service
UPnP	Universal Plug and Play
VLAN	Virtual Local Area Network

Glossary	Description
NTP	Network Time Protocol
STUN	Simple Traversal of UDP over NAT
PSTN	Public Switched Telephone Network
WLAN	Wireless Local Area Network